

SQUARE SCRUB[®]

Versatility²

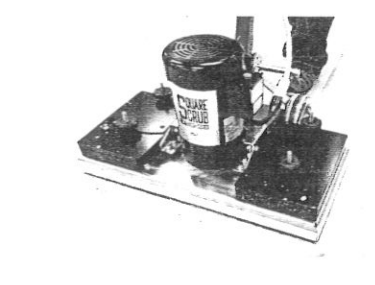

EBG SERIES FLOOR PREPARATION MACHINES

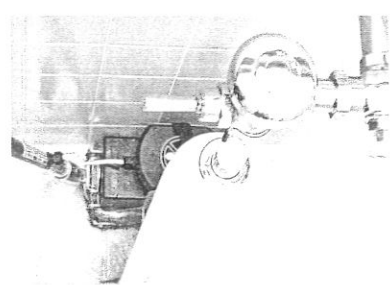
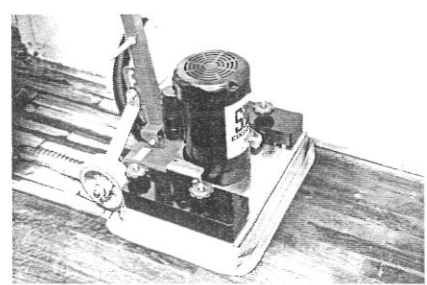
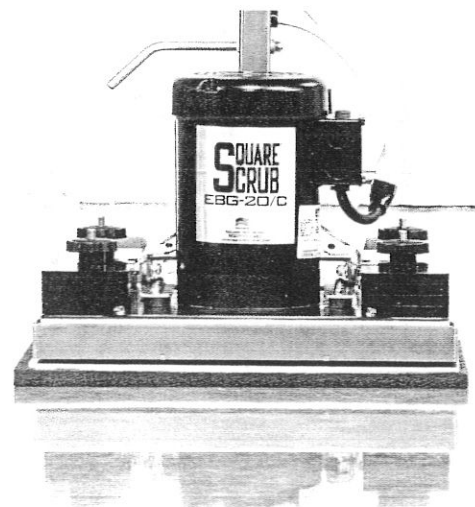
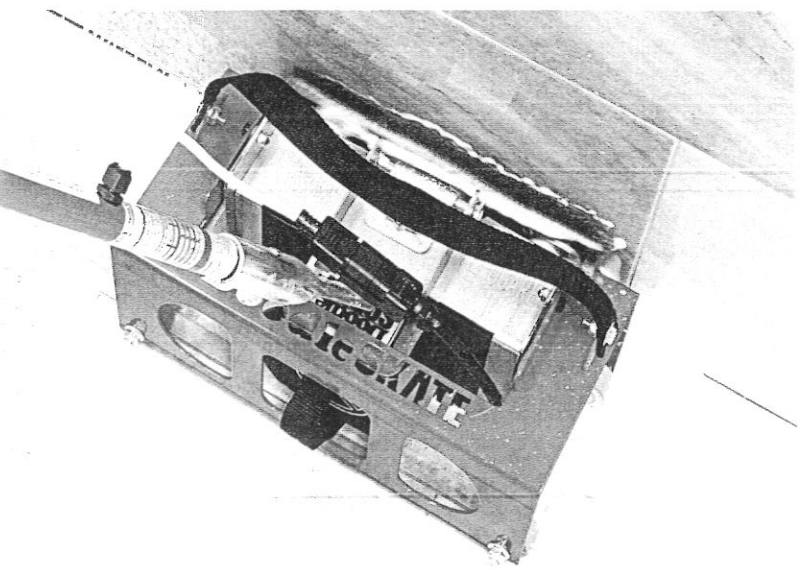

Introducing...



EBG-20/C

SQUARE SCRUB[®] Versatility² PIVOT

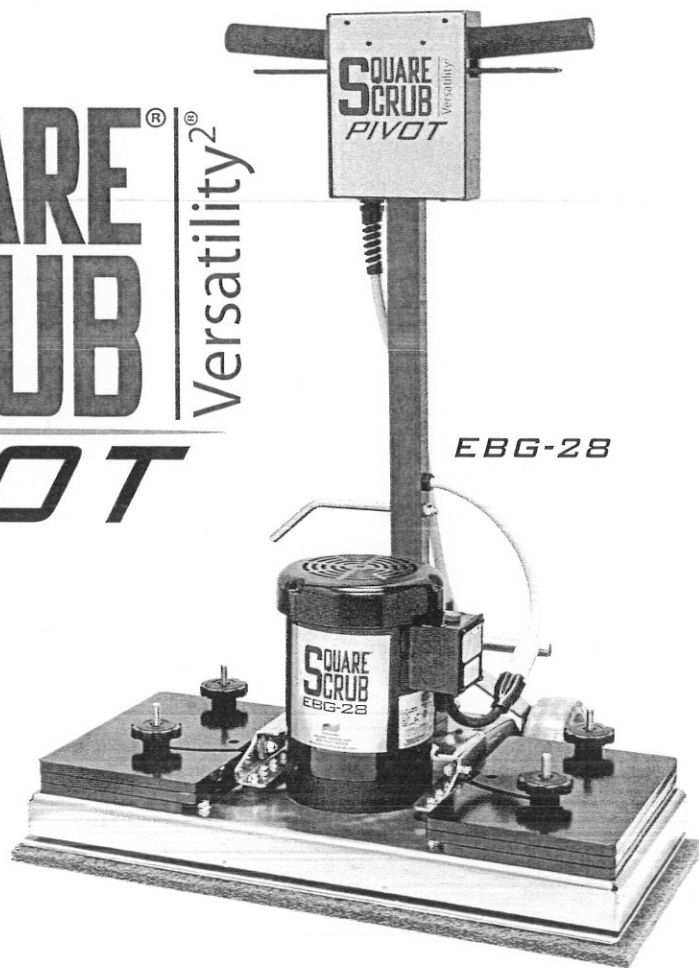

EBG-28

INNOVATION evolved

New pivoting head
for balanced
contact & easier
control.

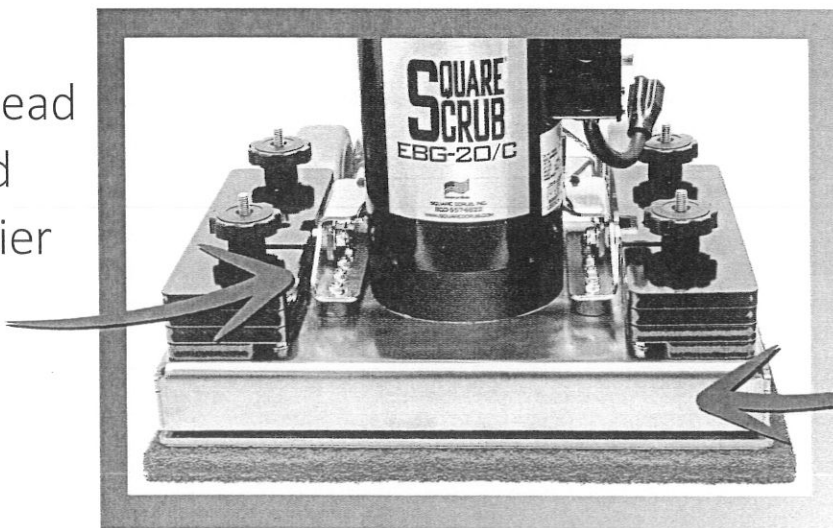

Redesigned sleek
7 gauge stainless
steel base.



Smooth Pivoting Action

The new pivoting head releases the control handle from the bottom of the base, allowing the machine to pivot freely front to back.

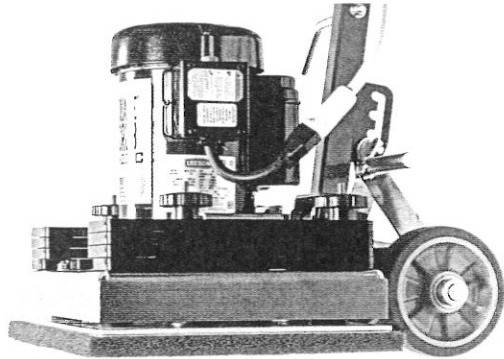

This pivoting motion follows uneven floors more efficiently.

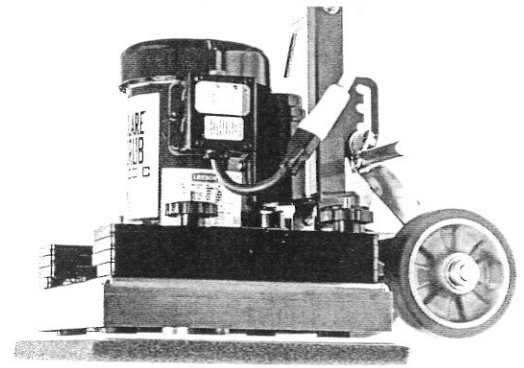

Near perfect weight distribution

The new floating design allows the head to have near perfect front to back and side to side weight distribution.

Near perfect weight distribution allows the entire pad to make equal contact with the floor, allowing equal distribution of the work across the entire pad.

Other designs place more pressure on the front or rear of the machine causing uneven pad wear.

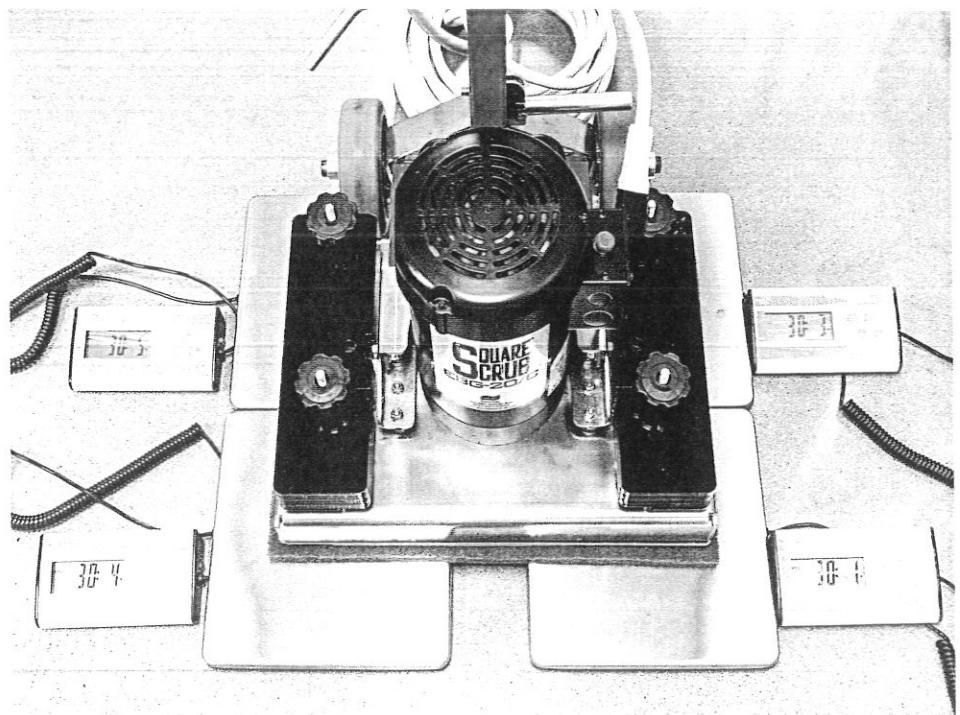

WWW.SQUARESCRUB.COM

800-557-6822



***Specifications & information contained in this catalog are subject to change without notice.

Anatomy of a Quality Machine

Improved Isolators

The new completely redesigned Pivot style machines all have an all new 2 ¼" long isolator. This is 50% longer than the previous isolator, which should result in longer part life. The longer isolator reduces stretching, which can lead to wear and tear.

Previous Isolator

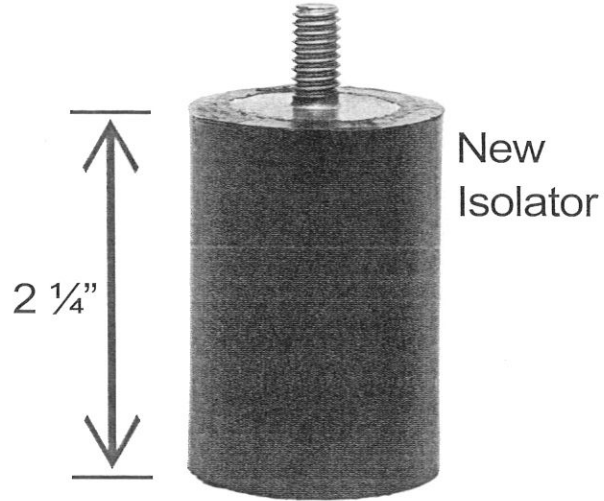
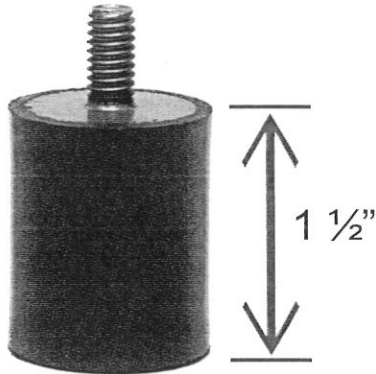

New Isolator

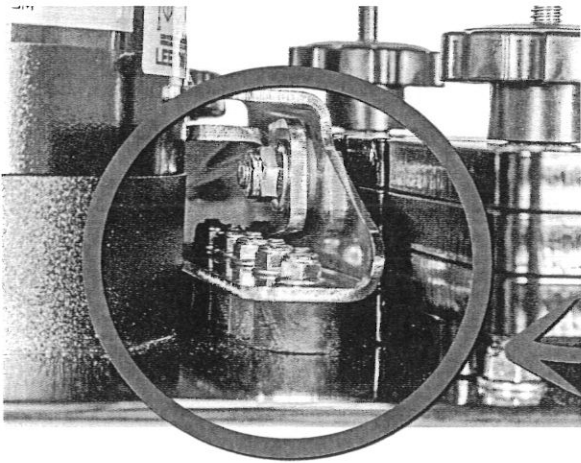

Vibration Reducing Isolators

The new Pivot design includes 10 low profile isolators mounted on the pivoting base. These isolators have been tuned and balanced to remove nearly all felt vibration by the operator.

Redesigned Dust Skirt

The new dust skirt now wraps all the way around, and overlaps in the back for better dust containment and removal.

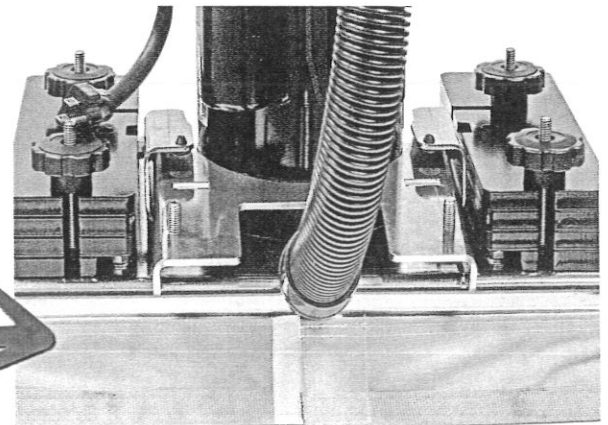

Versatility²

**SQUARE
SCRUB**®
Versatility²
www.squarescrub.com | 800-557-6822

New Trigger Assembly

The new trigger is much more robust and sensitive at the same time. It is now locked in place with steel guide pins riding in nylon bushings for smooth action. The handle is now a fully solid welded steel assembly.

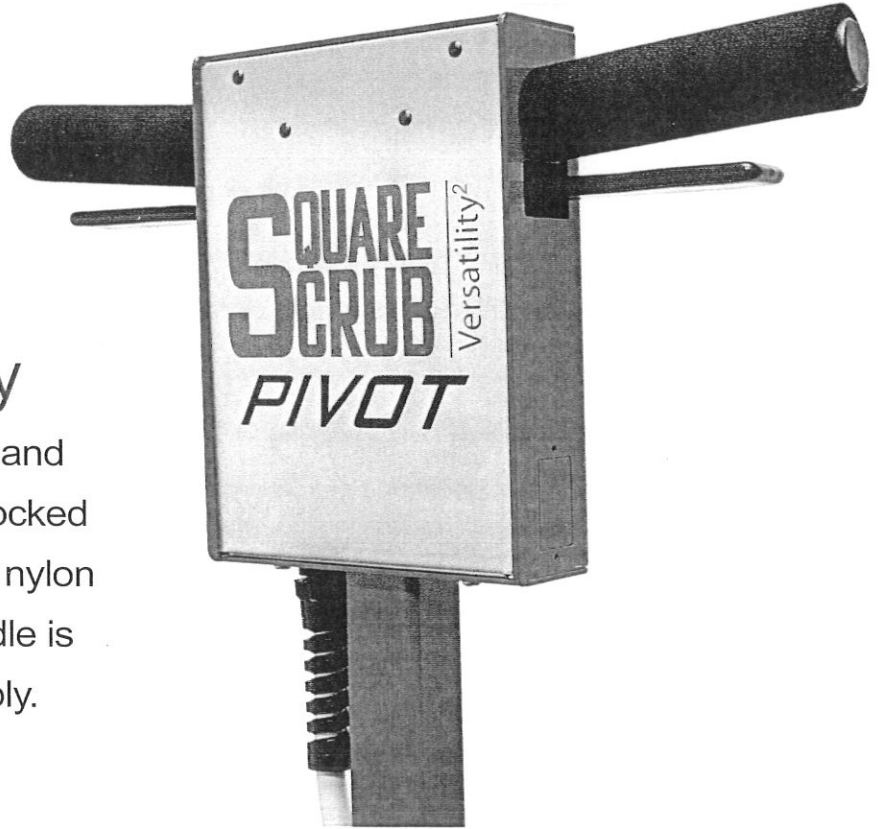

Two-Piece Handle

The new optional two-piece handle uses two additional knobs to release the operator handle and cord from the base. Taking this weight off makes the machine lighter and easier to load for transporting.

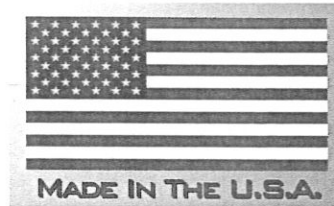
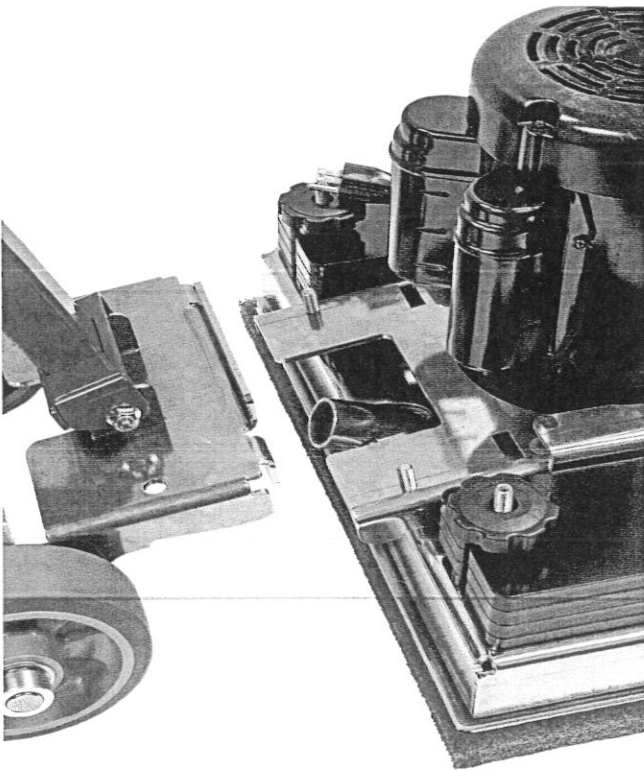

WWW.SQUARESCRUB.COM
800-557-6822

***Specifications & information contained in this catalog are subject to change without notice.

New & Improved Handle

Adjustable Handle

Now that the operator handle no longer impacts the weight of the head on the floor, it can be adjusted with freedom.

Older non-floating designs are very sensitive to the position and weight of the handle requiring the full upright position to be kept at all times.

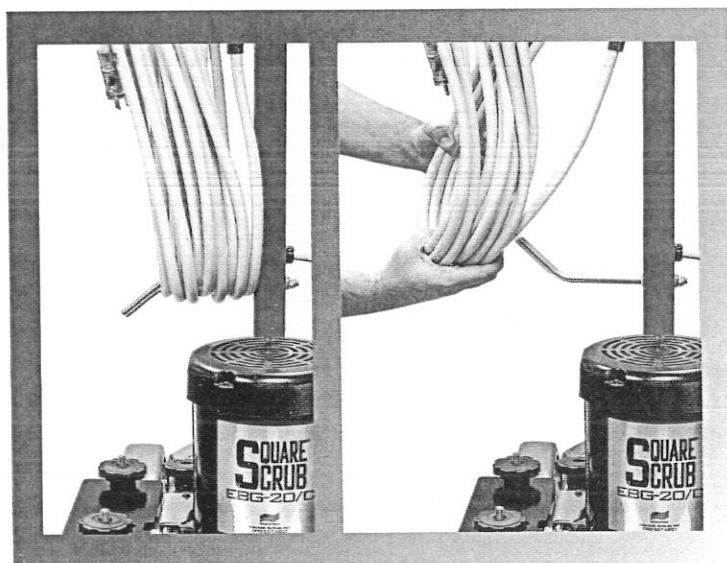
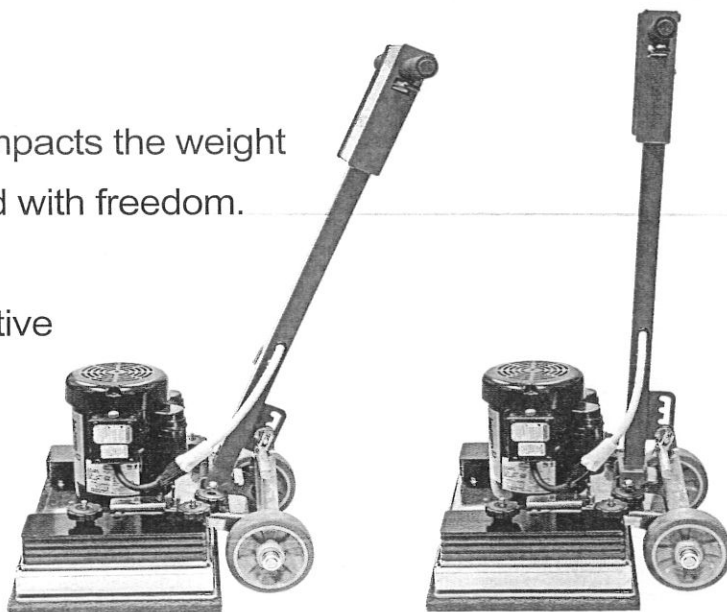

Quick Release Cord Wrap

With just a quick twist the new cord wrap unwinds the entire cord, and gets the machine to work quicker.

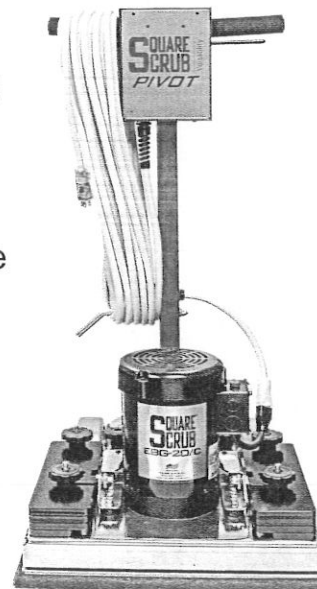

Optional Features

Hour Meter



Manual Power Switch

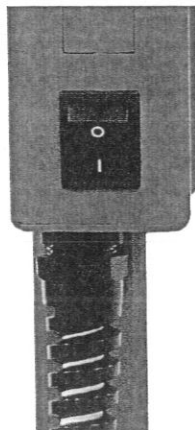

Extra Weights

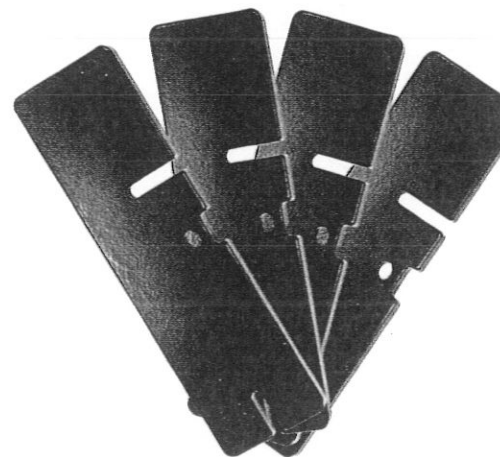

Adjustable Machine Weight

Ideal Weight Distribution = Even Surface Contact

6.4lb EBG-20/C Slotted Weights

13.2lb EBG-28 Slotted Weights

With Square Scrub[®], changing from floor type to floor type is easy with our slotted removable weights. Slotted weights make it easier to add weights for stone polishing or hardwood floor sanding, then remove weights to clean carpet in the next room. The EBG-20/C can adjust to accommodate up to 232 lbs.

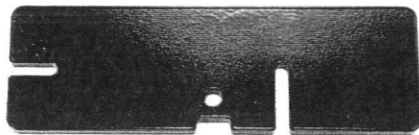

EBG-20/C

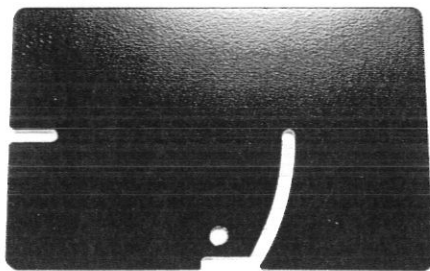

EBG-28

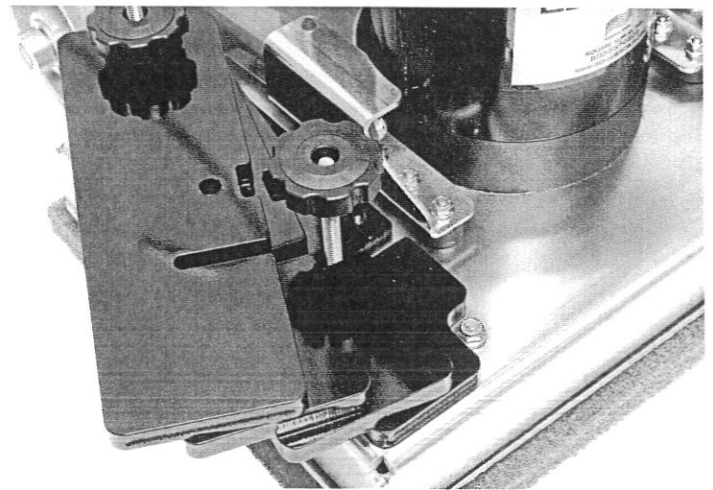

Grip Face

9" SS 051103V

20" SS 142003V

28" SS 142803V

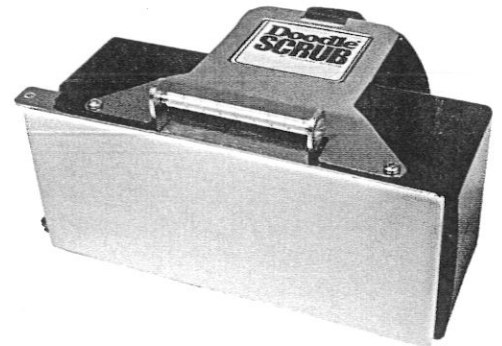
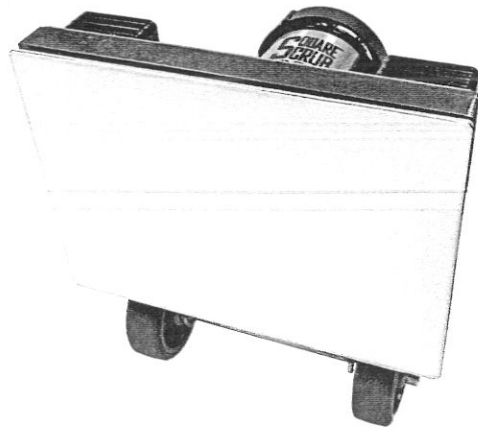

Our grip face allows any tool to adhere even better to the machine by significantly reducing slippage. Reducing slippage between the pad and grip face causes less friction between the pad and the plate. This allows more power transfer to the work surface, and reduces pad wear. Many of our products adhere directly to the grip face, without the need for drivers. The Square Scrub[®] grip face covers the entire plate in a single sheet, and is more chemically resistant. Most competitors use multiple strips, which can leave the bearing system vulnerable to chemical contaminants.

New Bearing Seal

ECCENTRIC ASSEMBLY WITH ADDITIONAL TOP SEAL

The new top seal adds two additional layers of protection to help prevent bearing failure caused by harmful contaminants.

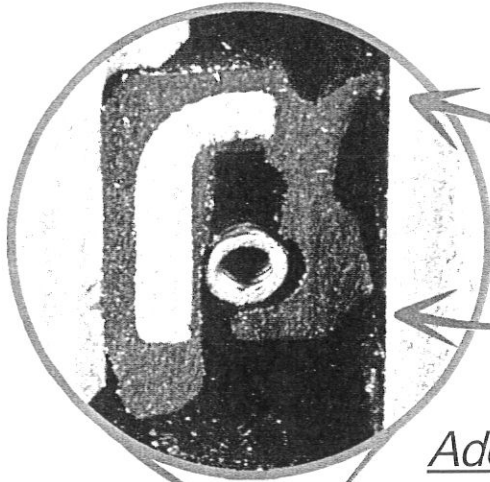

Additional Seal

Additional Seal

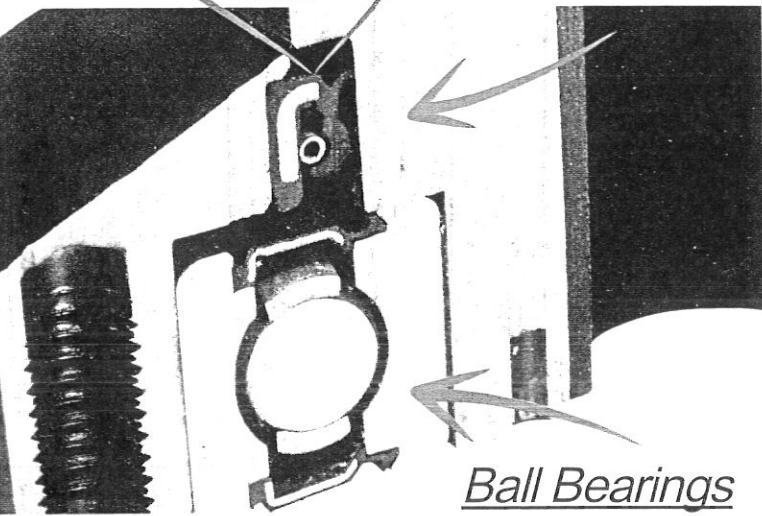

Ball Bearings

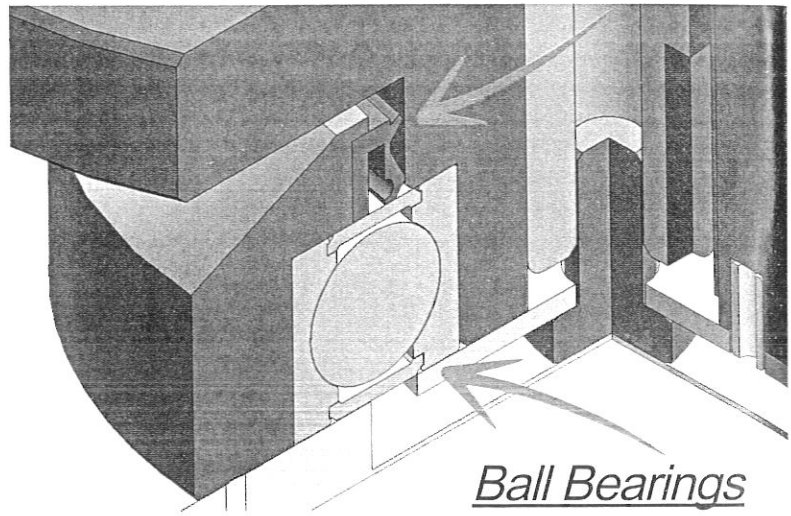

Ball Bearings

**ALUMINUM DRIVER PLATE
WITH THROUGH HOLE**

**NEW ALUMINUM DRIVER PLATE
WITHOUT THROUGH HOLE**

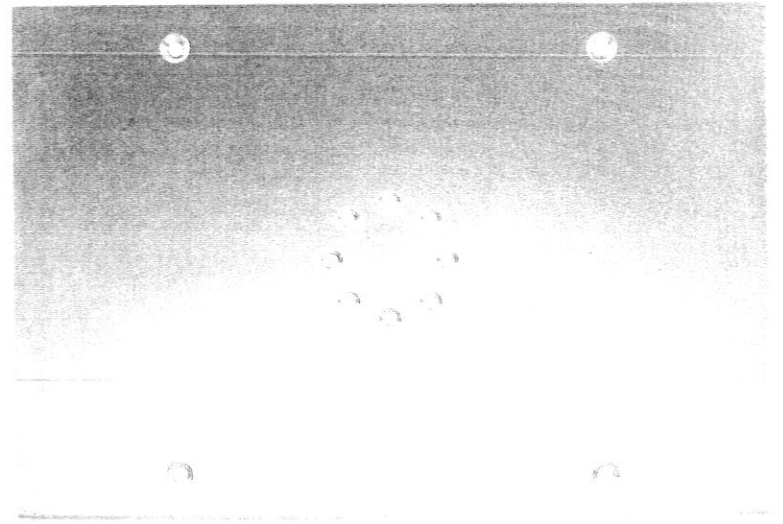
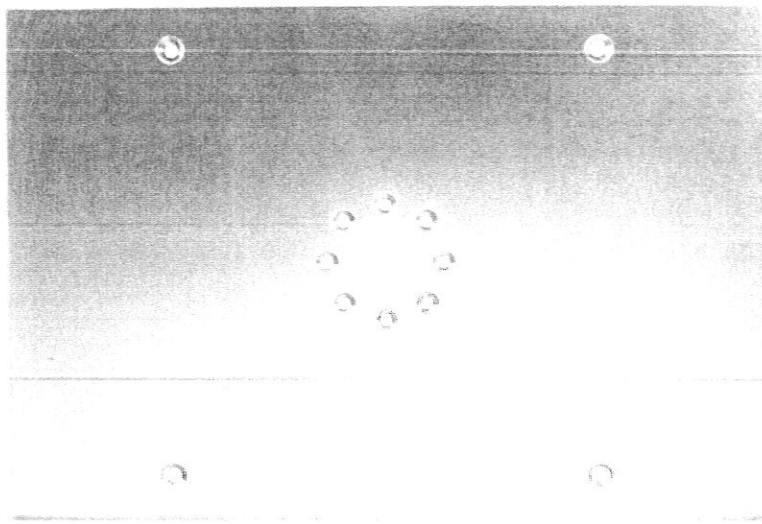

The new solid bottom plate prevents contaminants from attacking the bottom of the bearing. Combined, these new features should prevent bearing failures!

Base Plate Assembly with Seal

EBG-20/C BASE PLATE ASSEMBLY WITH SEAL SS 142015SEAL SOLD INDIVIDUALLY

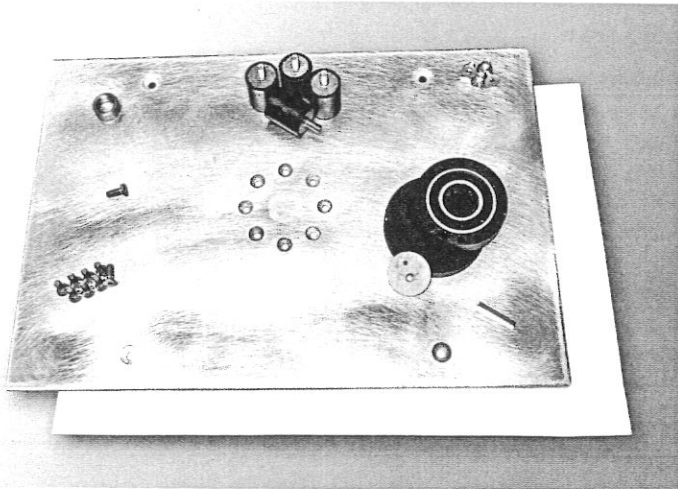

This kit contains everything needed to replace the eccentric assembly for the EBG-20/C. When replacing, Square Scrub® recommends installing new isolators as well. Included are: aluminum driver plate, 4 isolators, motor shaft spacer, motor shaft cap bolt, bearing bolts, eccentric assembly, crush washer, eccentric assembly key, grip face, anti-seize, & 100% silicone.

EBG-28 BASE PLATE ASSEMBLY WITH SEAL SS 142815SEAL SOLD INDIVIDUALLY

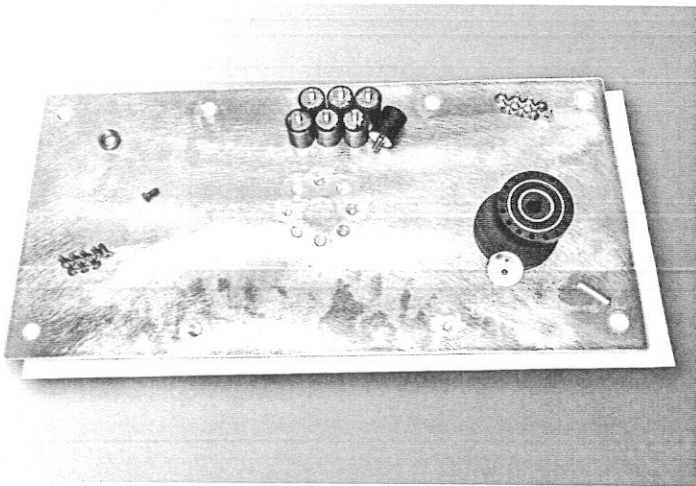

This kit contains everything needed to replace the eccentric assembly for the EBG-28. When replacing, Square Scrub® recommends installing new isolators as well. Included are: aluminum driver plate, 8 isolators, motor shaft spacer, motor shaft cap bolt, bearing bolts, eccentric assembly, crush washer, eccentric assembly key, grip face, anti-seize, & 100% silicone.

Scan Me!



Watch the how-to
installation video

Visit us online for full installation instructions
and detailed video tutorials.

WWW.SQUARESCRUB.COM
800-557-6822

***Specifications & information contained in this catalog are subject to change without notice.

HEPA Dry Vac System

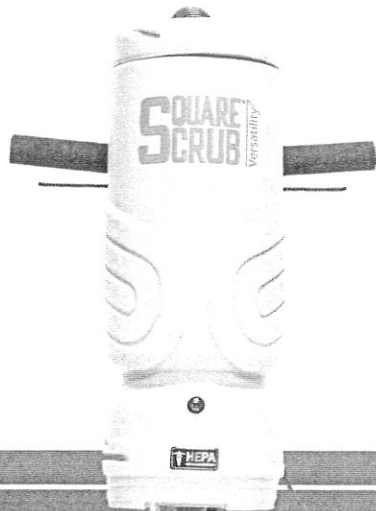

HEPA & CRI Gold



HEPA Dry Vac Kit

SS EBG-HDVK - Sold Individually

The Square Scrub® HEPA Dry Vac Kit** attaches to all 20" & 28" Square Scrub machines*. Since it only draws 4.5 amps, it can be plugged directly into the machine power with the included adapter. This vacuum can be converted to a backpack vac with optional accessories.

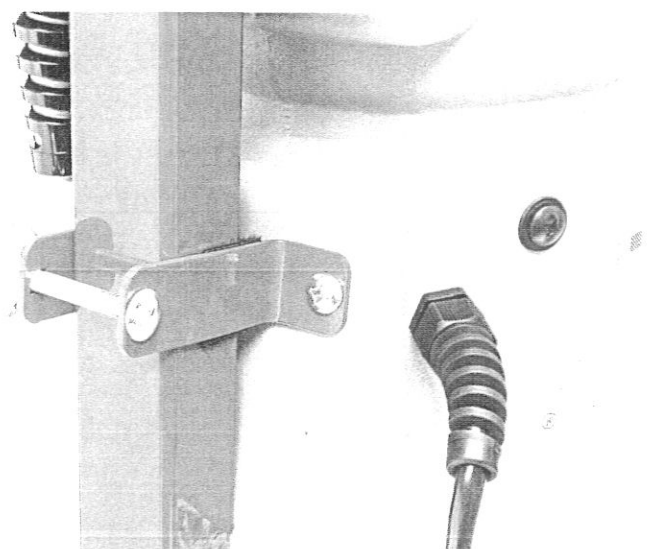
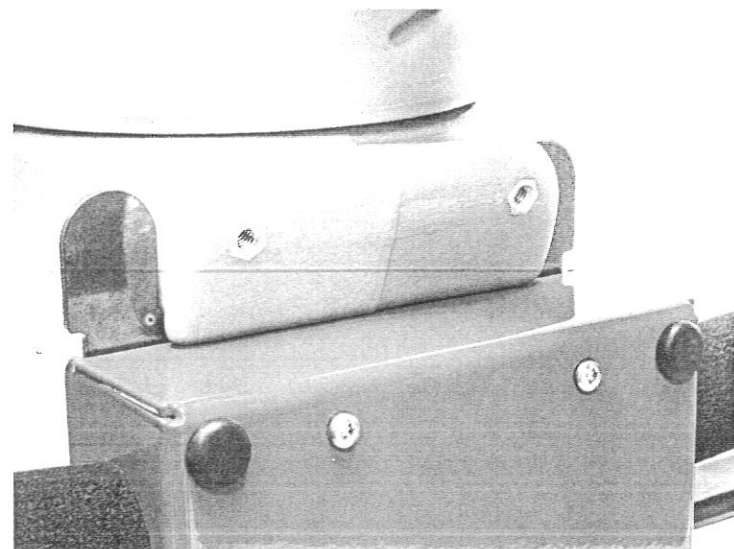
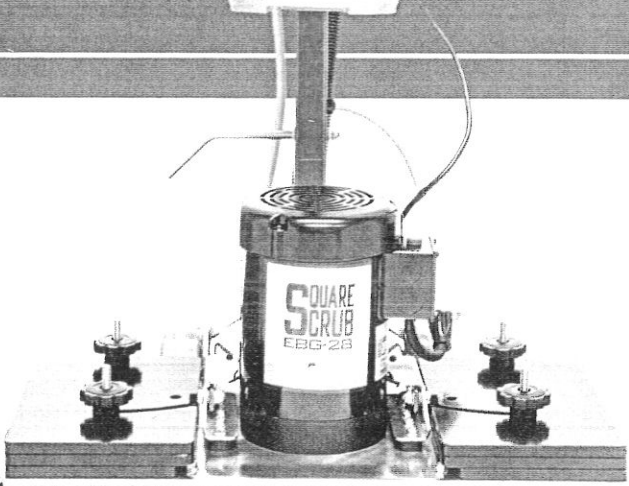

Solution Tank

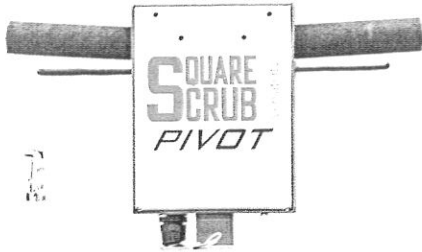

SQUARE SCRUB
Bucket on a Stick

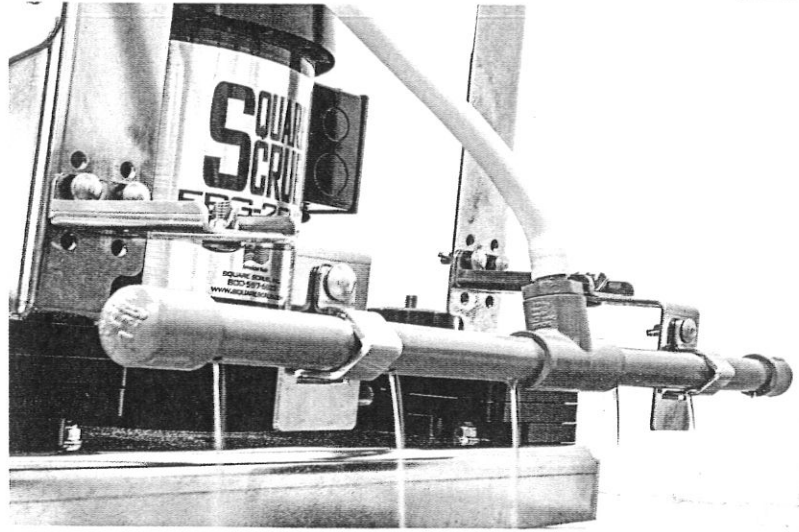

— New & Improved ! —

Solution Tank

SS EBG-WTS - Sold Individually

The Square Scrub® Solution Tank attaches to all 20" and 28" Square Scrub® machines. The new and improved Solution Tank includes a relocated water line that feeds into a front mounted dispersion bar. Liquid is now delivered in front of the machine for optimal performance.

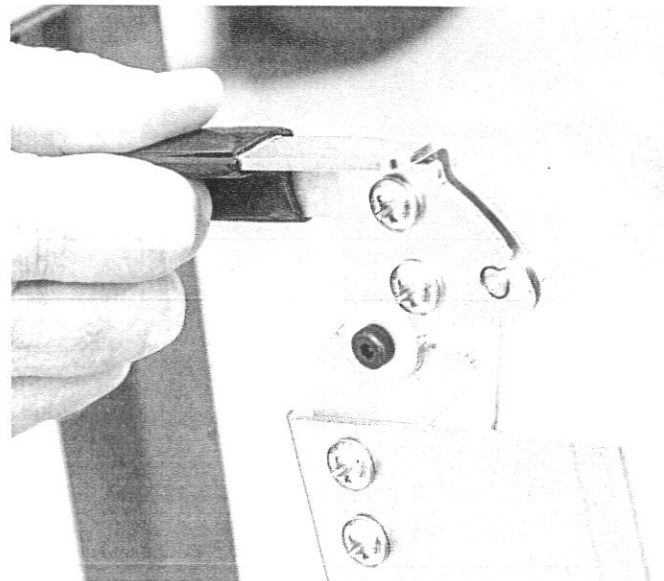
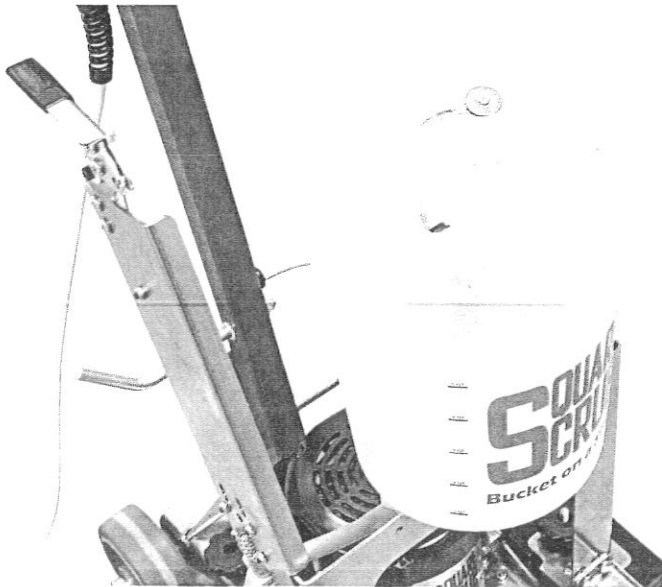
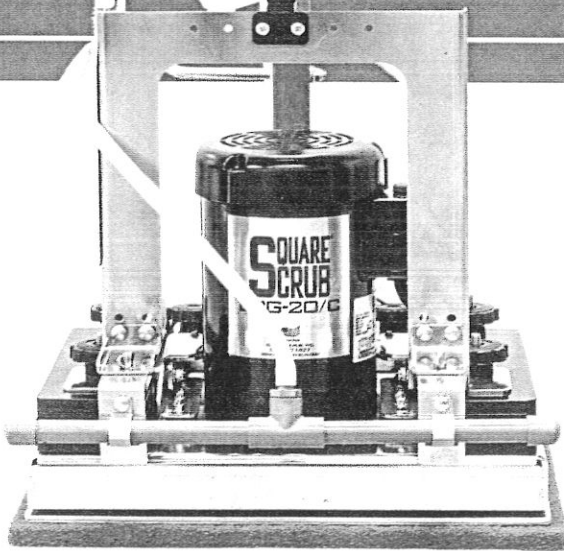

***Specifications & information contained in this catalog are subject to change without notice.

✓ Another
Tough Job Made

EASY!

with

**Doodle[®]
SCRUB**
BY SQUARE SCRUB

Doodle Scrub Goes Where You Can't

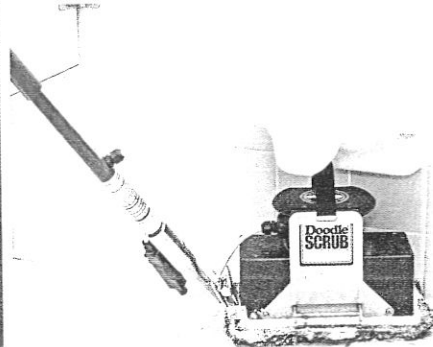

The Doodle Scrub[®] EBG-9 is GREAT for a multitude of floor surfaces, and it is the perfect companion to the Square Scrub[®] EBG-Series Floor Preparation Machines.

The Doodle Scub[®] has a new patent pending handle/base design that allows the handle to be attached on either the end or middle of the base for absolute

Versatility²[®]

*Machine shown with optional carry strap.

Reaches Under Urinals

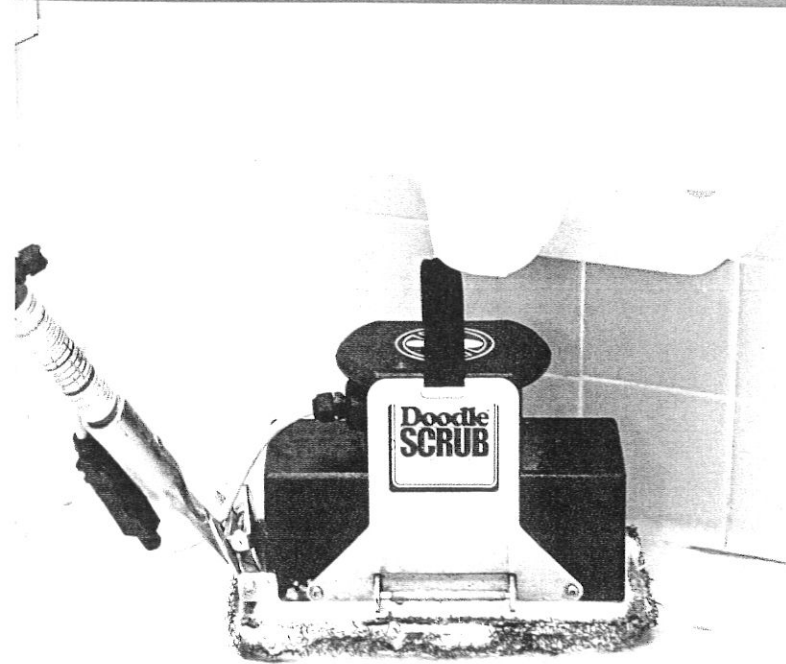

Works Great on VCT

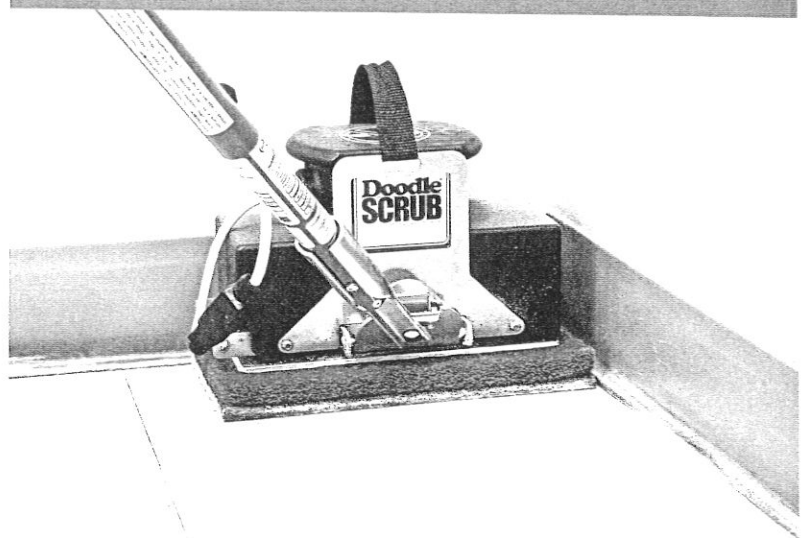

Cleans Behind Toilets



Works Great on Stairs

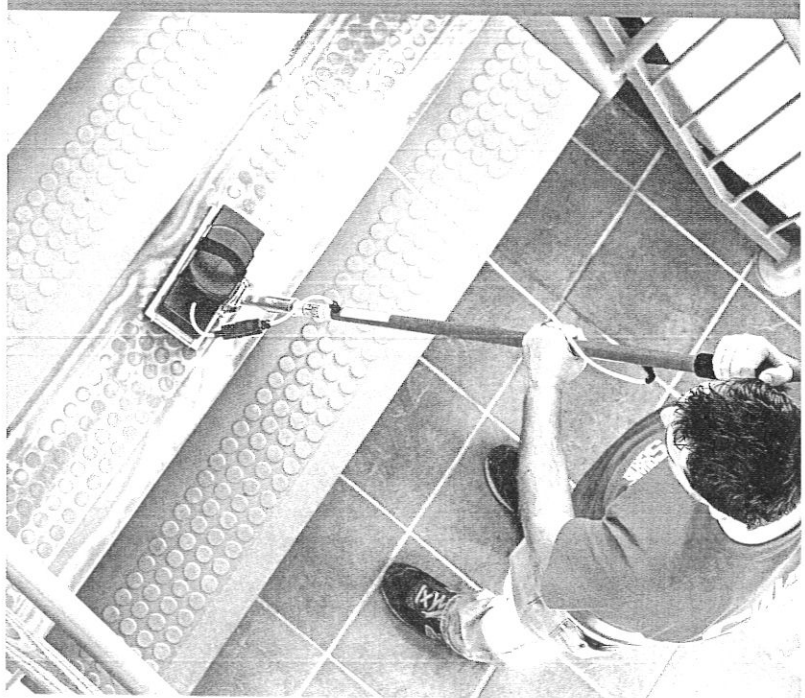

Scan Me!

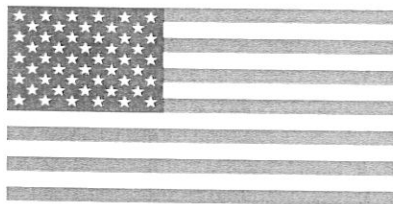
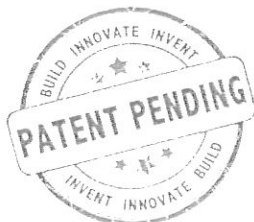

MADE IN THE U.S.A.

SQUARE SCRUB®
Versatility²

www.squarescrub.com | 800-557-6822

See the Doodle Scrub® in Action.

***Specifications & information contained in this catalog are subject to change without notice.

The innovative patent pending Doodle Scrub® handle attaches to the base in TWO different ways giving the user maximum Versatility²



Clip the handle in the middle of the base,

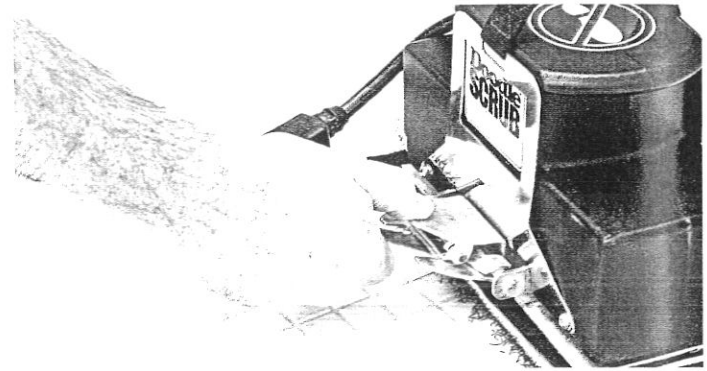
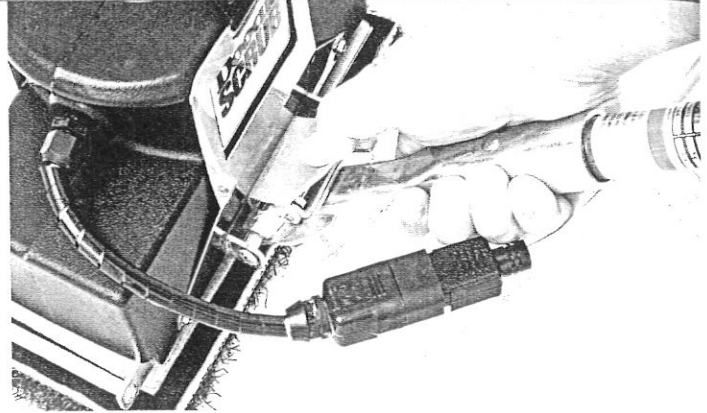

Or end of the base to get in those tight spaces.

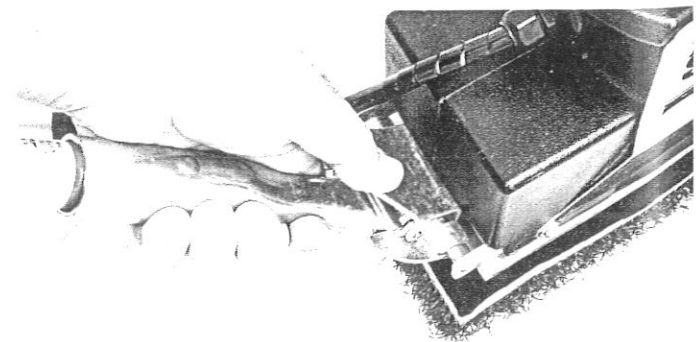
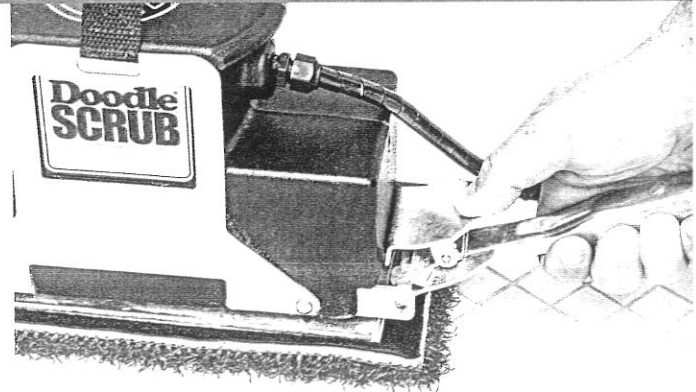

Look at how much dirt we pulled by only using water.

BEFORE

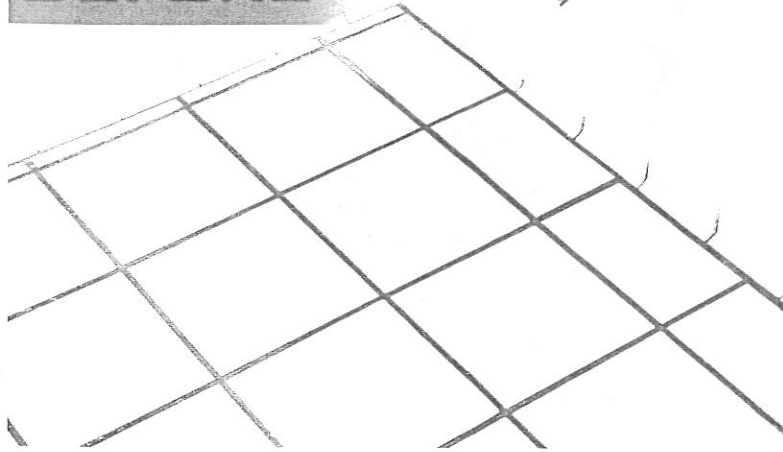

AFTER

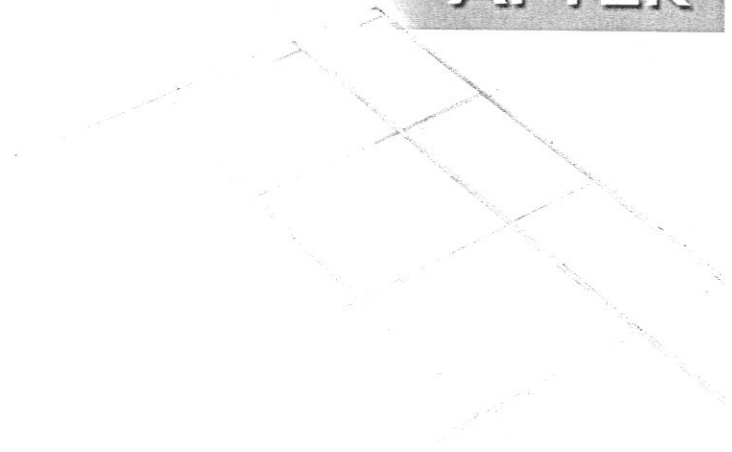

Results shown from adding water, no chemicals needed.

BEFORE

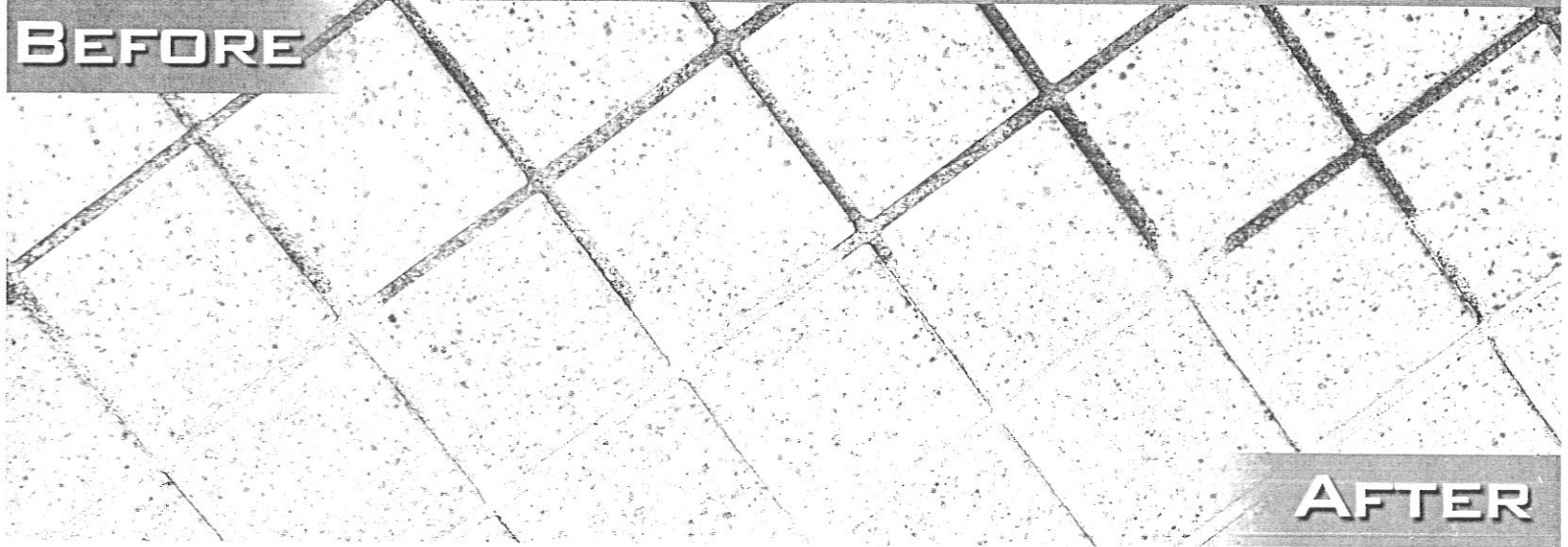

AFTER

Works great on laminate flooring too!

BEFORE



AFTER



Baseboards

Doodle[®]
SKATE
BY SQUARE SCRUB

✓ Another
Tough Job Made

EASY!

Baseboard Scrubbing Attachment

Converts the Doodle Scrub[®] into the most highly effective
baseboard scrubbing machine available.

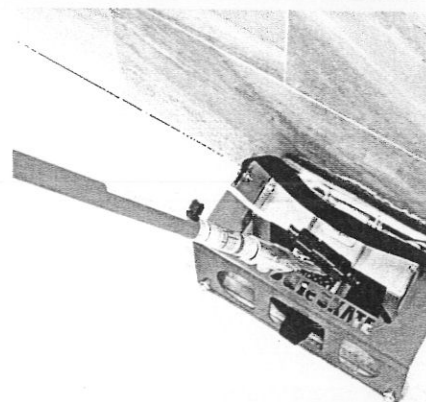
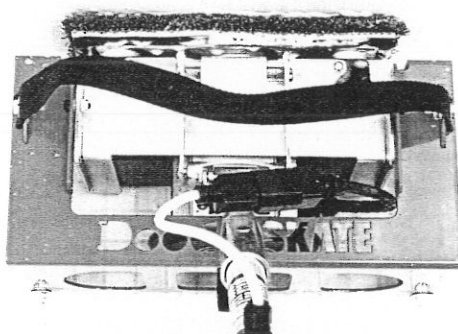
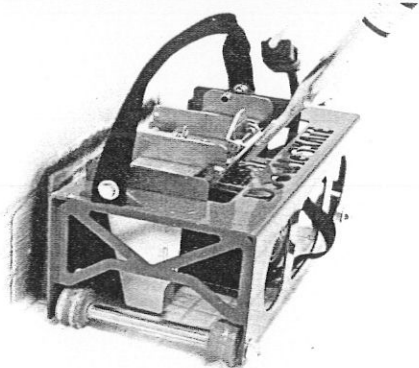

BEFORE

See the
Doodle Skate[®] in action.

AFTER



Scan me!

Baseboards

Durable nylon carry strap
for easy transport.

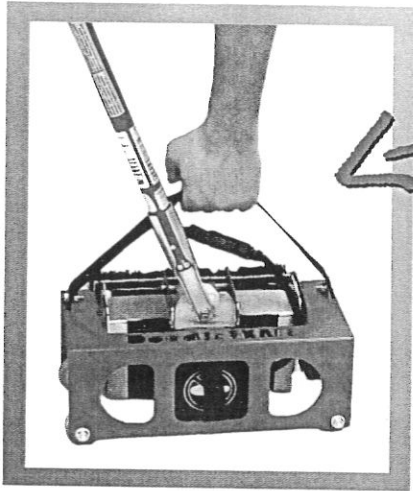

Smooth pivoting action
adjusts to wall contours.

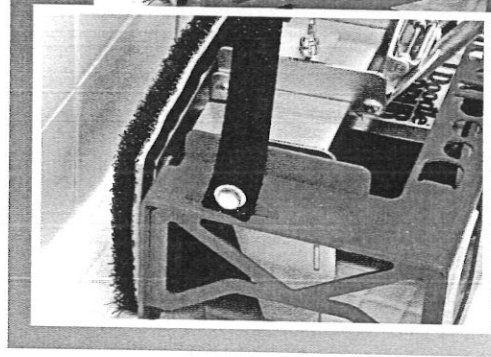
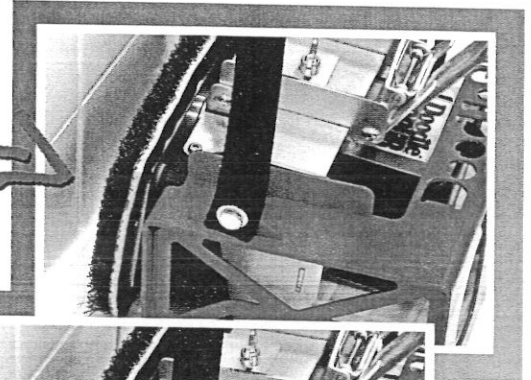

Easy gliding non-marking wheels.

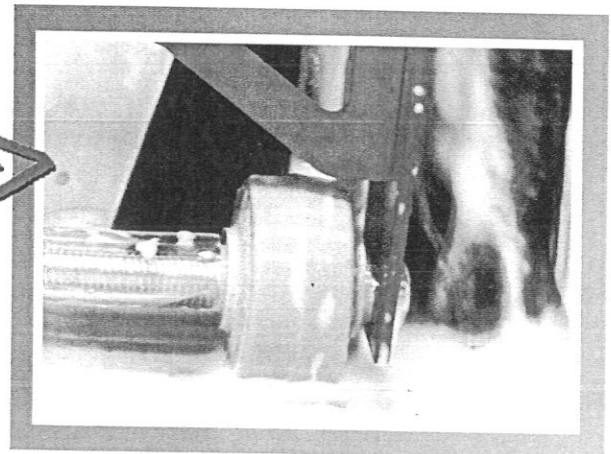

Blue Tile & Grout pad work great
on tile & grout, baseboards,
stair risers, & more.

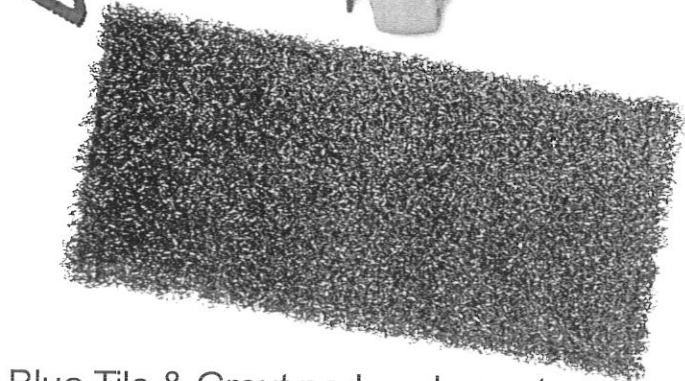

***Specifications & information contained in this catalog are subject to change without notice.

Full Pad Contact

Doodle[®]
SKATE
BY SQUARE SCRUB

Full pad contact for optimal cleaning

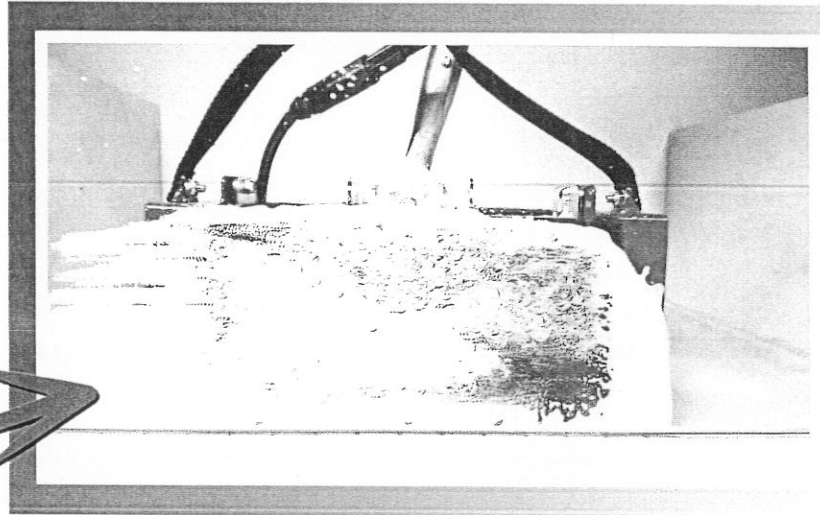

Innovators, Not Imitators

Doodle Skate[®] turns the scrubbing action parallel to the baseboard.

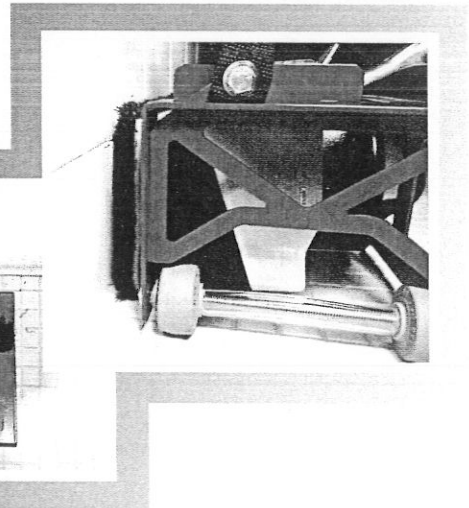
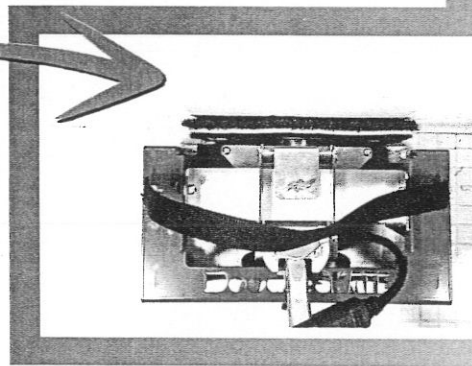

Upright machine baseboard attachments simply hit against the baseboard.

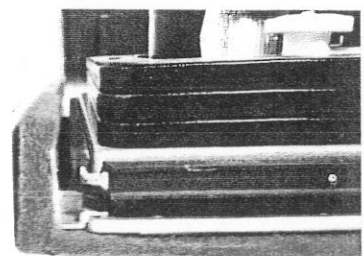
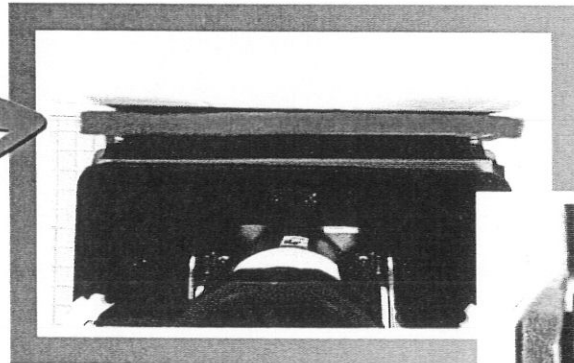

Doodle Scrub® Accessories

CARRY STRAP — **SS 051190**

SOLD INDIVIDUALLY



Stainless steel side plates make it easier than ever to move and transport your Doodle Scrub®.

DOODLE SKATE® — **SS EBG-9-SKATE**

SOLD INDIVIDUALLY



Turn the Doodle Scrub® sideways to scrub baseboards, tile & grout, and more at a 90° angle.

**Doodle Scrub® sold separately.*

HANDLE TRIGGER — **SS051180**

SOLD INDIVIDUALLY

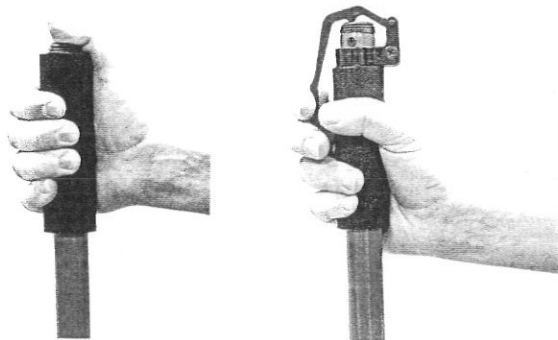

The Handle Trigger makes it easier than ever to operate the Doodle Scrub®. It can also help to reduce user fatigue.

***Specifications & information contained in this catalog are subject to change without notice.

The Ultimate Doodle Scrub® Experience

Doodle[®]
SCRUB
DELUXE
BY SQUARE SCRUB
SS EBG-9-DLX

Includes

Doodle[®]
SKATE
BY SQUARE SCRUB

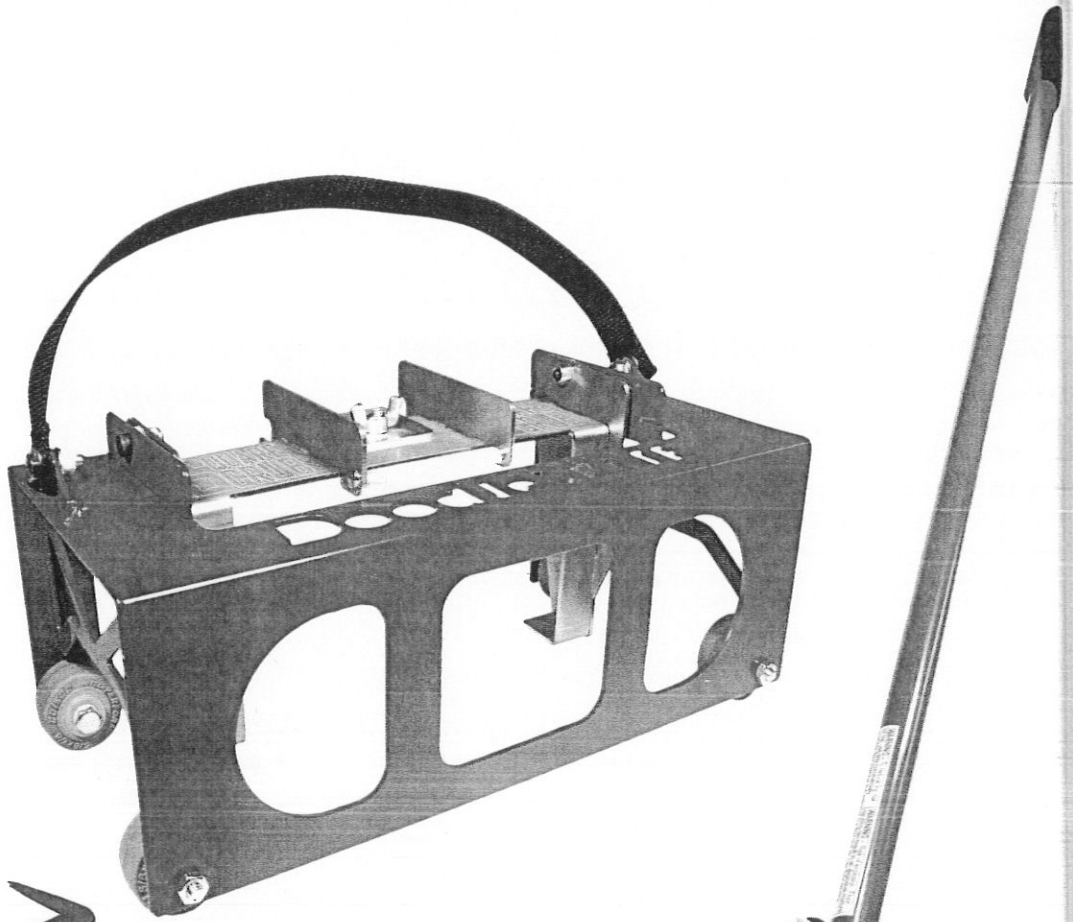

Includes

Doodle[®]
SCRUB
BY SQUARE SCRUB

with Stainless Steel
Carry Strap



One Package, All the tools

Also includes

7 - Blue Pads

2 - White Pads

5 - White Driver Pads

2 - Tile & Grout Pads

3 - SHO Pads

2 - Xtreme Sponge

5 - SQP Pads

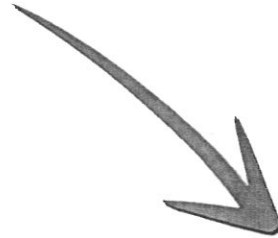

**SQUARE[®]
SCRUB** | Versatility²



WWW.SQUARESCRUB.COM

800-557-6822

***Specifications & information contained in this catalog are subject to change without notice.

Long Lasting
American Made Components

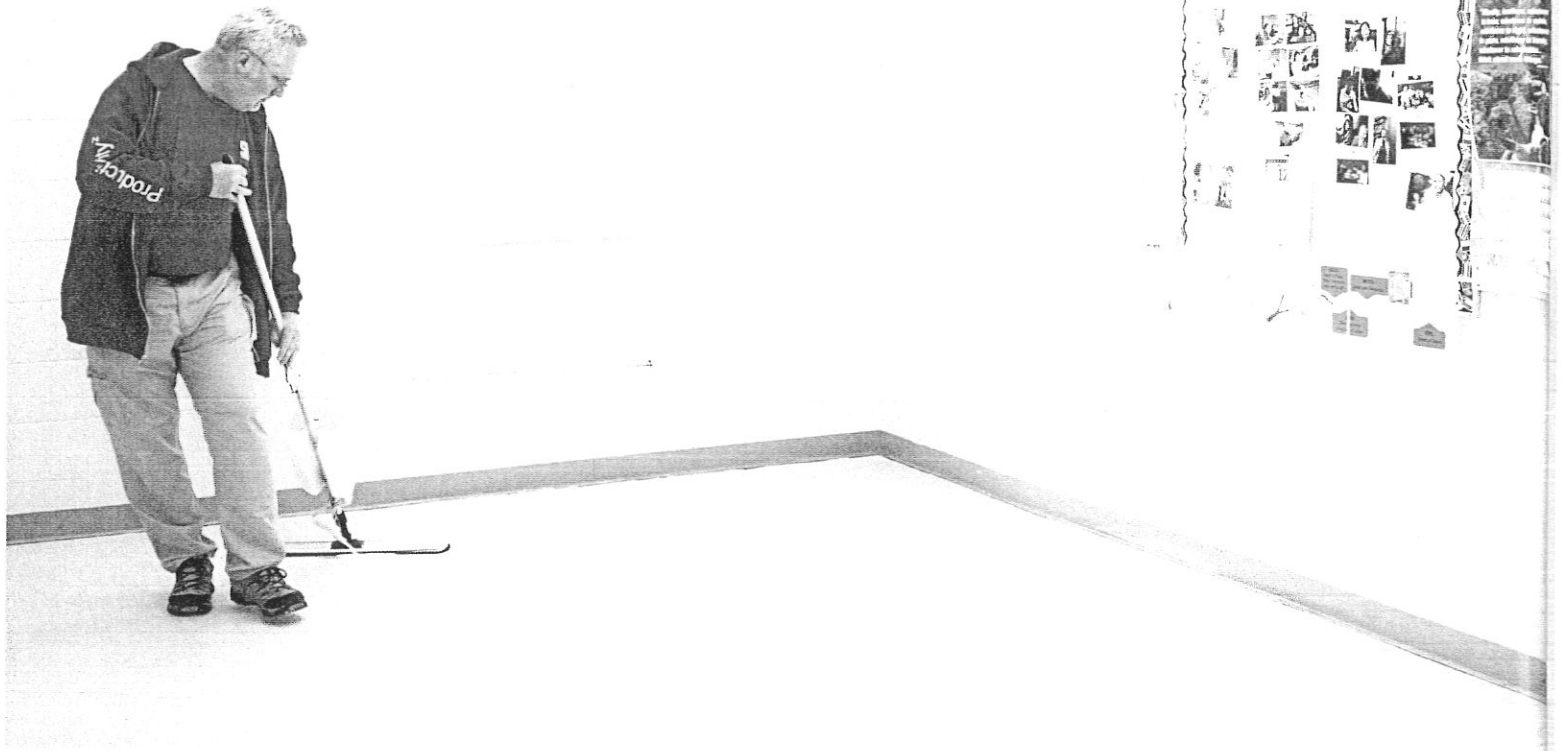

Bucket on a Stick®

18" - SS BOS18

24" - SS BOS24

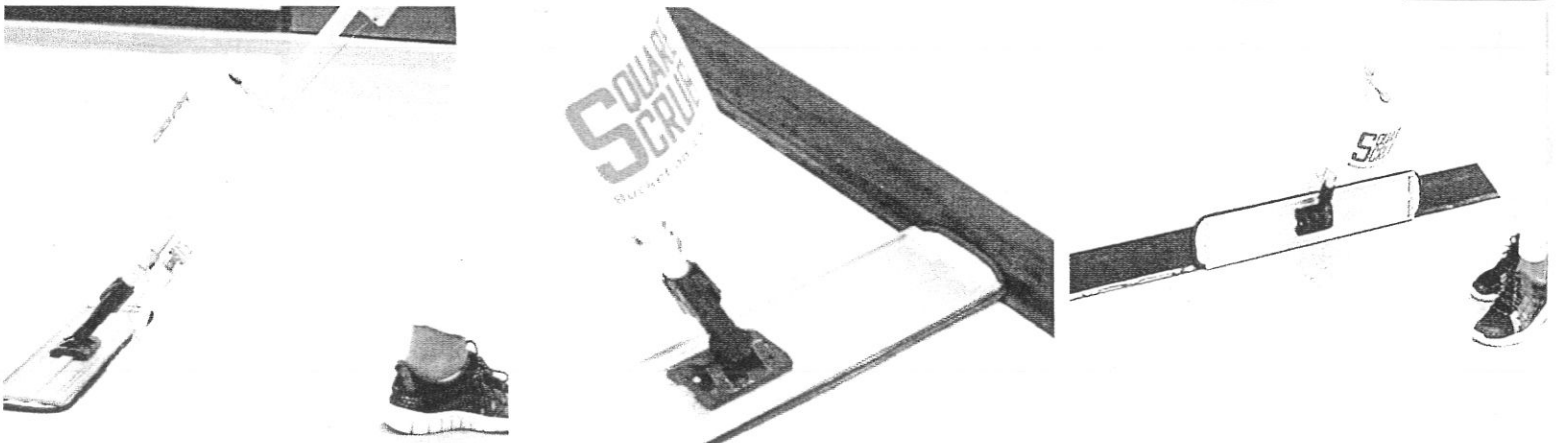

Microfiber Mop Heads

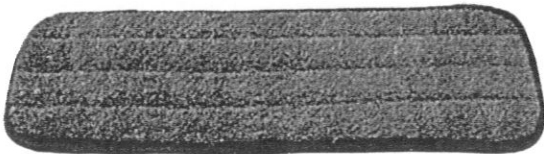

18" - SS 0403Z

24" - SS 0406Z

*Apply floor finish efficiently and evenly
with the microfiber mop head.*

***Specifications & information contained in this catalog are subject to change without notice.

**Extra large opening for
easy pour**

Easy to clean

**Holds 5 quarts
of finish**

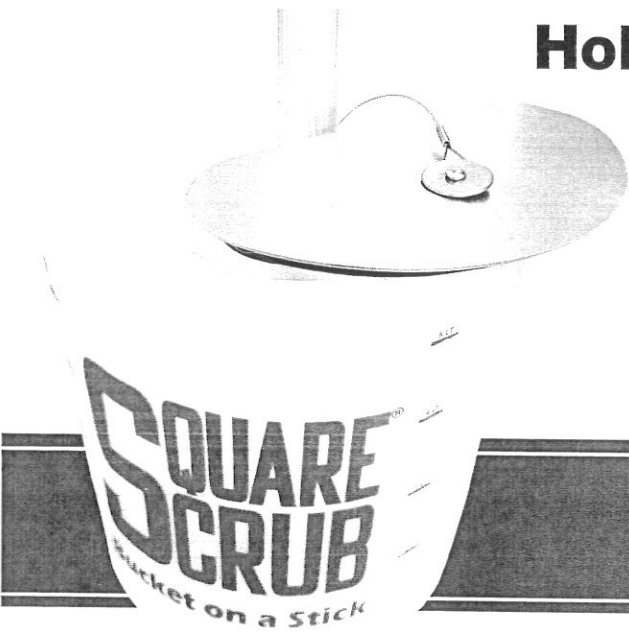
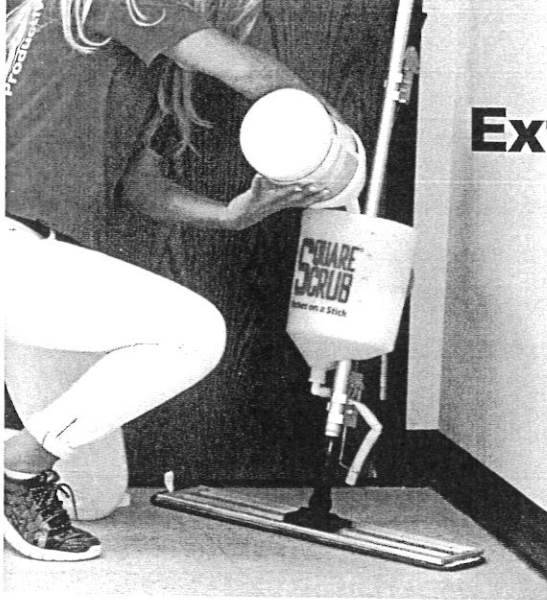

**Aluminum Handle with an easy
to replace Bicycle Brake Cable Release.**

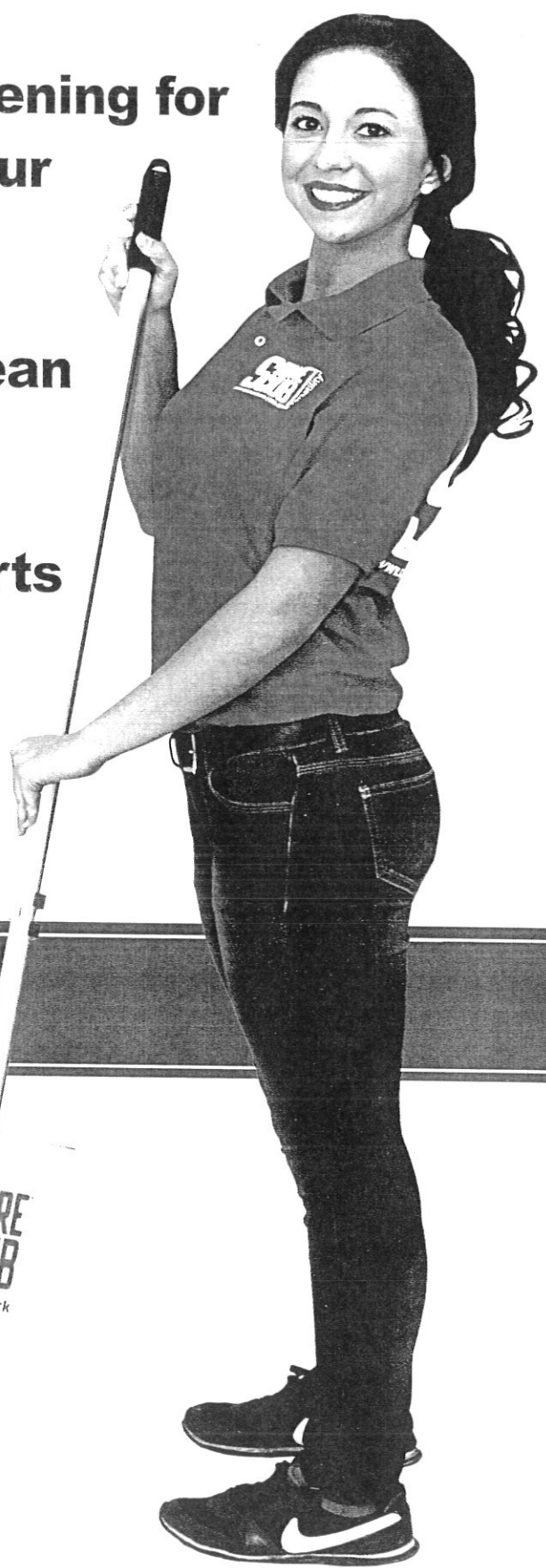

***Specifications & information contained in this catalog are subject to change without notice.

Stone Polishing

3M TRIZACT™ TZ Diamond Abrasive Strips

Creates a smooth, highly refined surface.

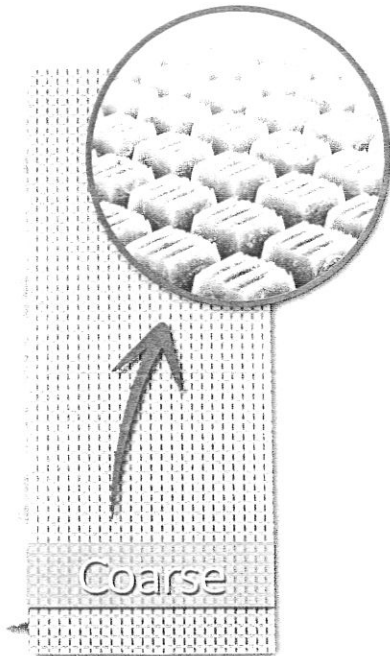

3M TRIZACT™
Diamond TZ Gold
TZD GOLD - Sold Individually

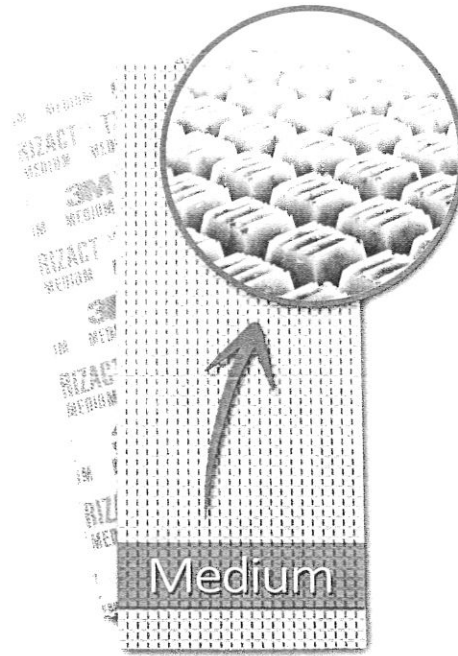

3M TRIZACT™
Diamond TZ Red
TZD RED - Sold Individually

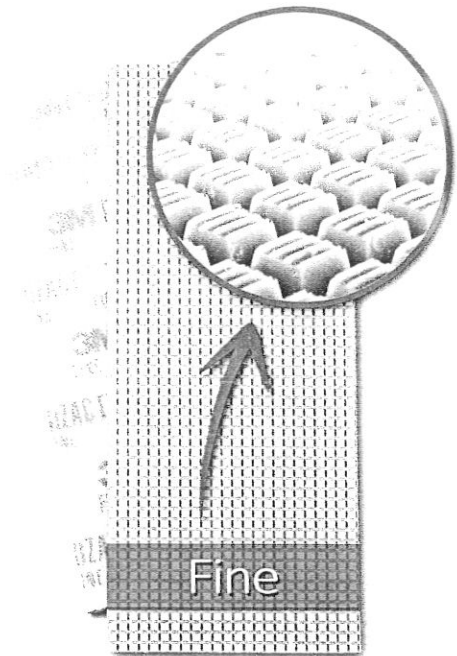

3M TRIZACT™
Diamond TZ Blue
TZD BLUE - Sold Individually

Only 3 diamond steps!

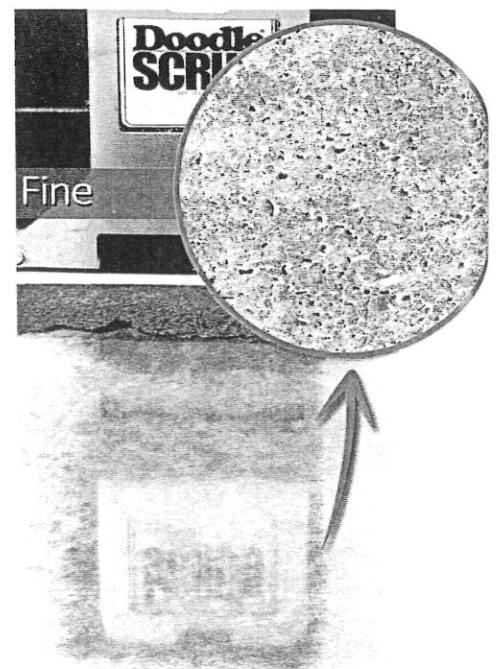
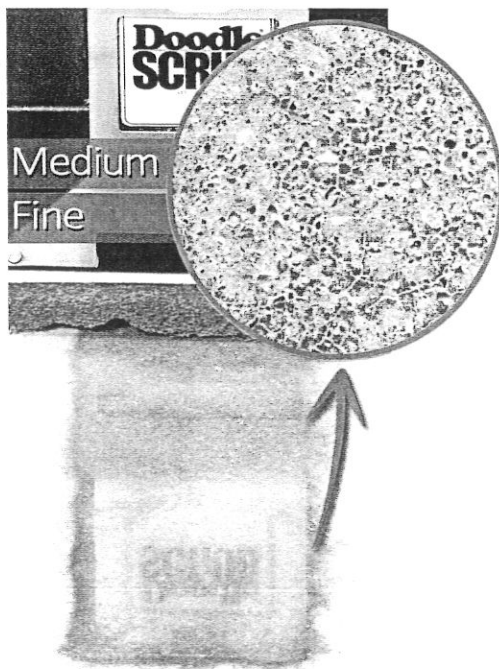
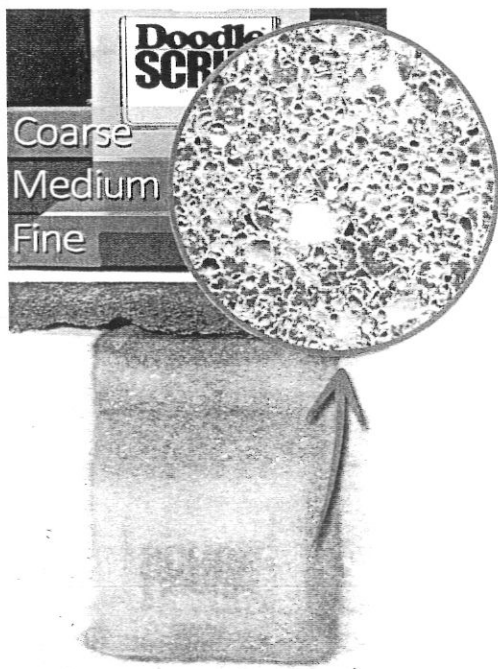

One Size Fits All

Great for concrete, marble, terrazzo, & more.

Diamond Strips can be set in rows of 2 or 3.

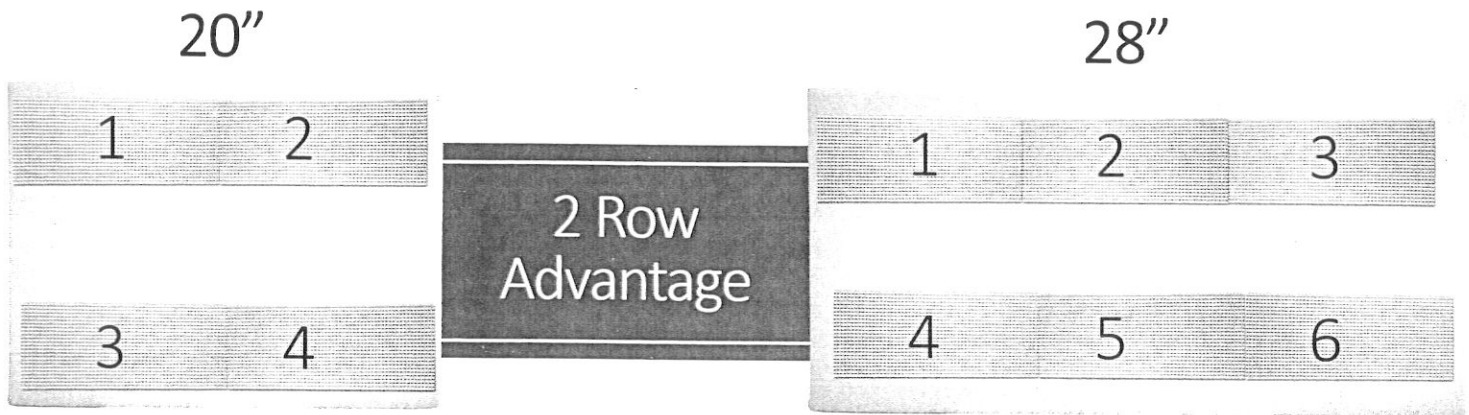

Fewer diamonds used = Cost effective

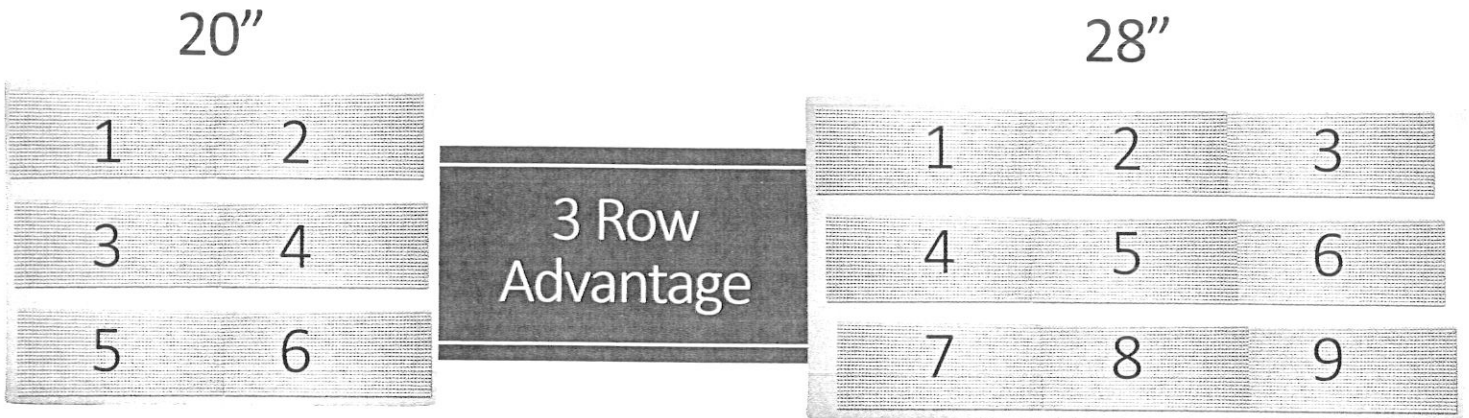

More diamonds used = Time saved

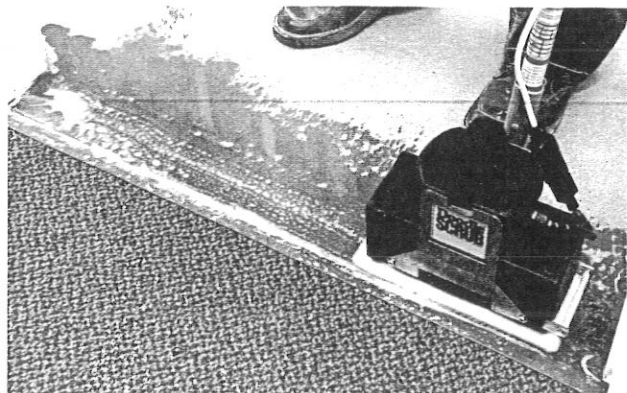

The Doodle Scrub[®] can be used to polish tighter spots & doorways.

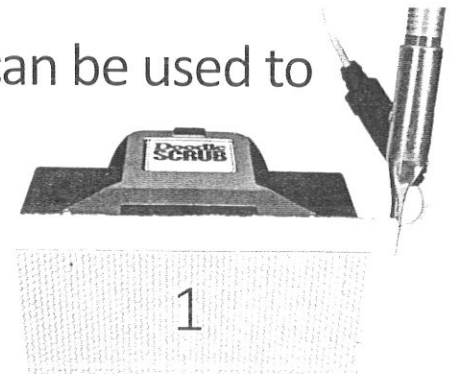

***Specifications & information contained in this catalog are subject to change without notice.

Stone Polishing

3M Scotch-Brite™ Purple Diamond Floor Pad Plus

Diamond coated floor pads for cleaning & polishing.

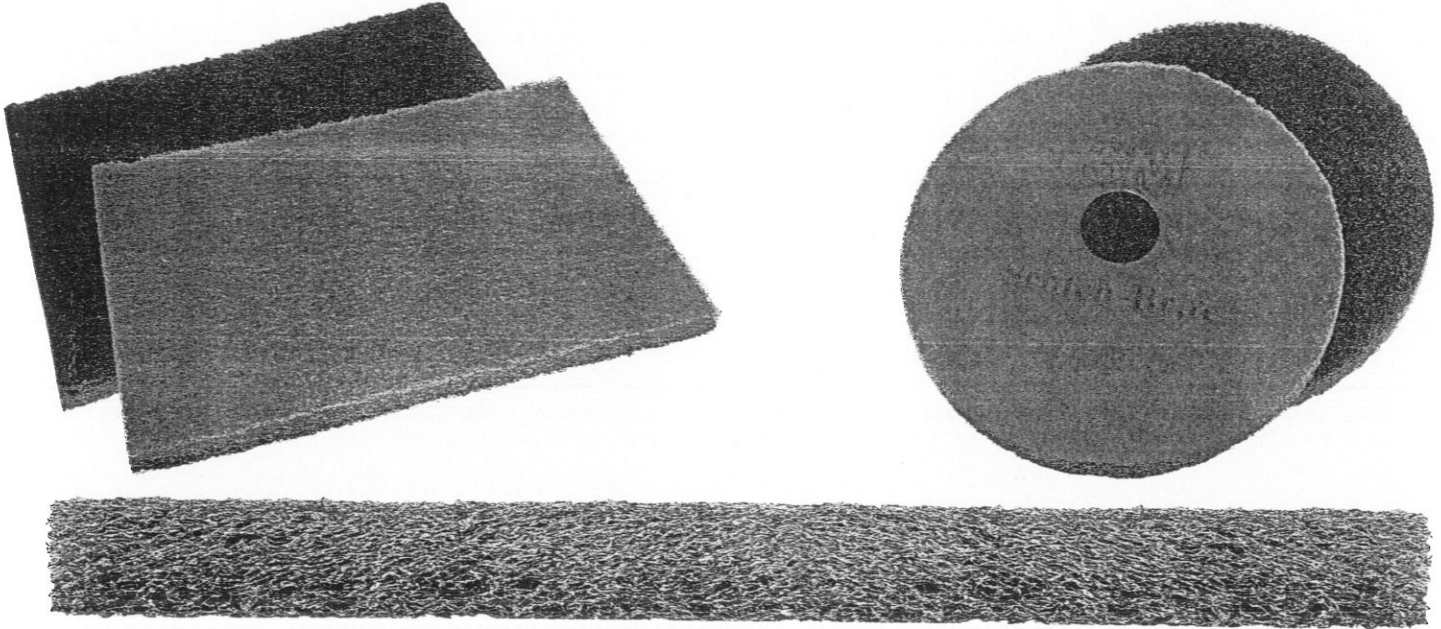

The dark purple bottom contains the diamond coated material.



Available for square & round machines.

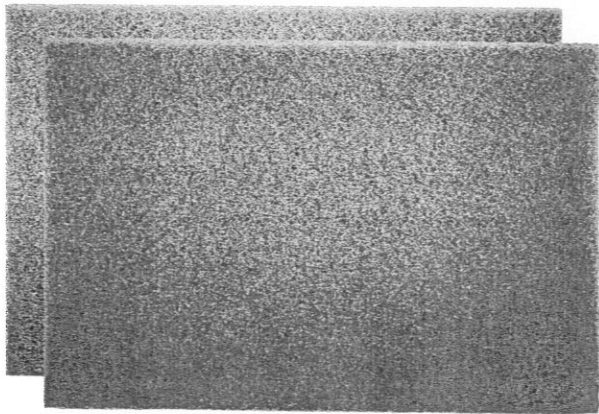

10.5" - P0511PD
20" - P1420PD
28" - P1428PD



19" - P1428PD
20" - P0020PD
24" - P0024PD
27" - P0027PD

Stone Polishing

3M Scotchgard™ Stone Floor Protector Hardener & protector for porous stone flooring.



- Fast drying, & thin coating.
- Easy to apply with the Bucket on a Stick.
- Great for concrete, marble, terrazzo, & more.
- Lower maintenance than typical finishes.
- Reduces floor maintenance costs.

Scan Me!



Watch the stone
polishing demo.

**SQUARE
SCRUB**®
Versatility²

***Specifications & information contained in this catalog are subject to change without notice.

Blue Tile & Grout Pad

- Made of the same blue scrubbing material that has already proven to clean better with the Doodle Scrub®.
- Integrated velcro backing extends the pad life and reduces slippage.

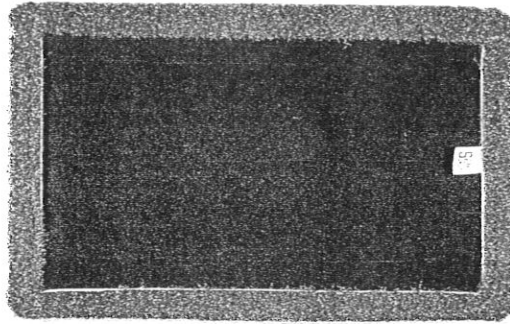

Inferior Green Material = Inferior Pad

- Longer and stiffer bristles scrub deeper, and outperform the traditional green tile & grout pads.
- The new Blue Tile & Grout Pad is nearly 1/2" thicker than the old green pad.
- More bristles per square inch. Cleans at least twice as good as the green pads.

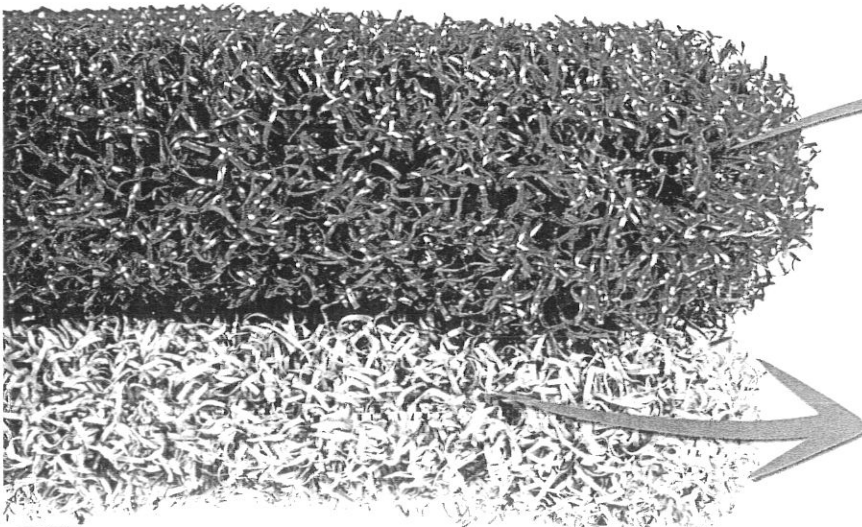
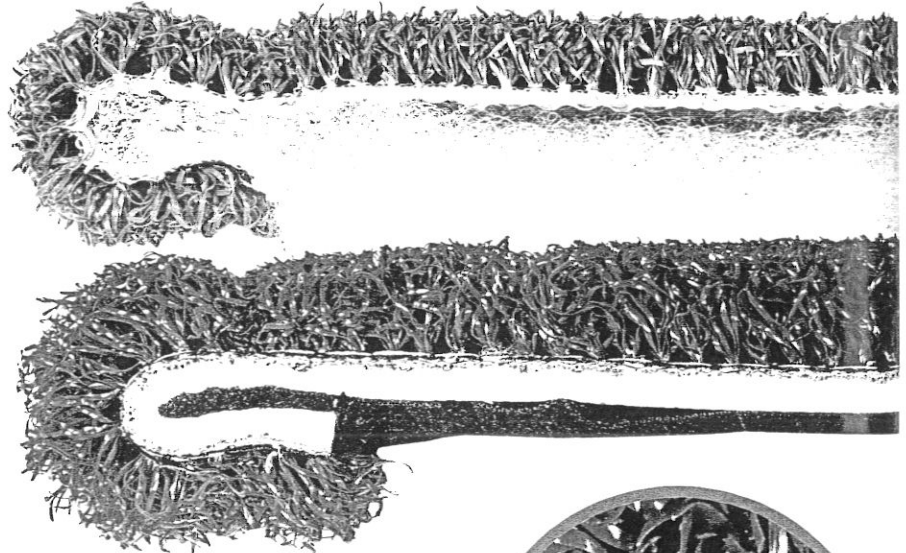

Lasts 3 to 6 times longer

Blue Tile & Grout Pad

10" SS P0511TGBV

The new Blue Tile & Grout pad is also available for the Doodle Scrub® EBG-9.

Works great on those hard to reach grouted areas.

Doodle
SCRUB
BY SQUARE SCRUB

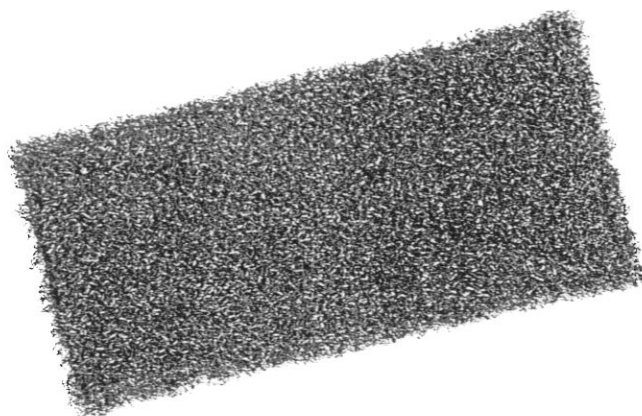

Sizes available for all EBG Machines

Blue Tile & Grout Pad



20" SS P1420TGB

28" SS P1428TGB

The new Square Scrub® Blue Tile & Grout Pad drastically outperforms the old style green pads. With longer bristles and more scrubbing material per square inch, the blue pad scrubs deeper and lasts longer than the traditional green pads.

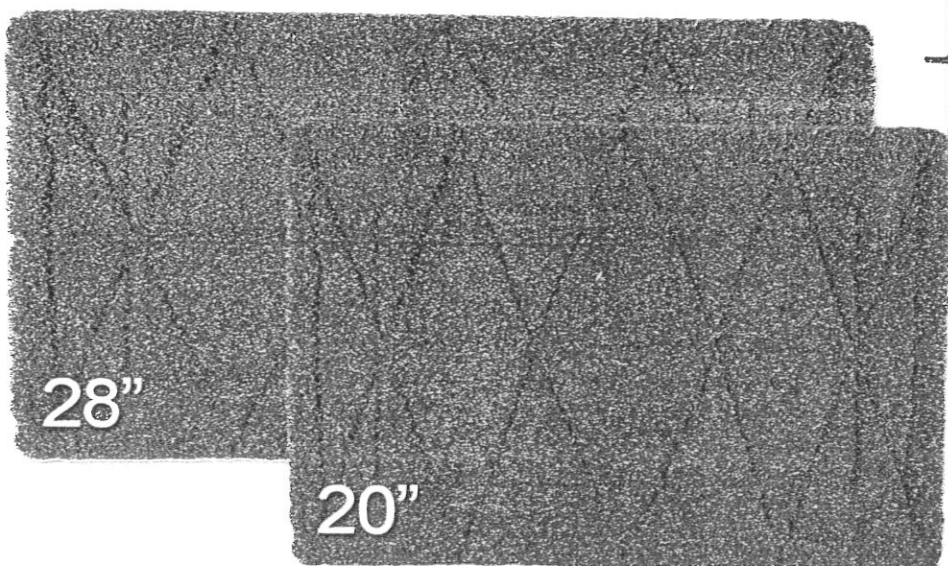
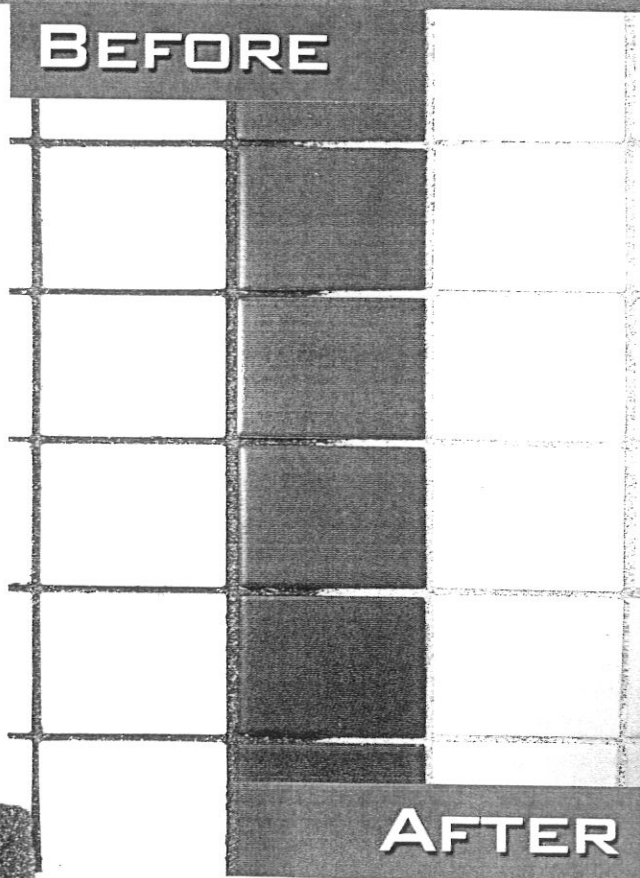

SQUARE
SCRUB Versatility²

www.squarescrub.com | 800-557-6822

***Specifications & information contained in this catalog are subject to change without notice.

Dry Prep VCT

The SQP Pad dry preps up to 3,600 sq ft of finished VCT surface per hour.

**SQUARE
SCRUB**®
Versatility²
www.squarescrub.com | 800-557-6822

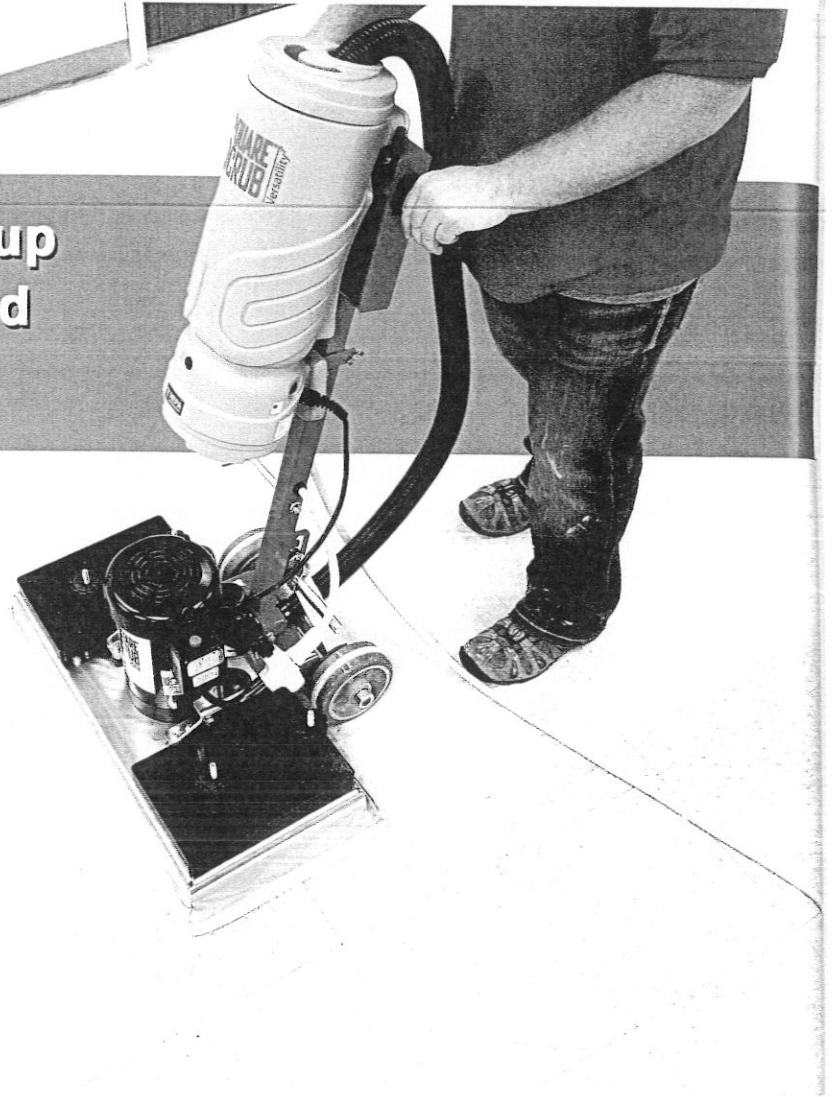

SQP PAD

10.5"	P0511SQP	60/CASE
20"	P1420SQP	10/CASE
28"	P1428SQP	10/CASE

The SQP pad is a thin pad designed to remove several layers of acrylic finish in preparation for recoating.

Use dry on VCT and Tile.

Chemical Stripping VCT

Use wet. The SHO Pad is only for the heaviest of chemical stripping jobs.

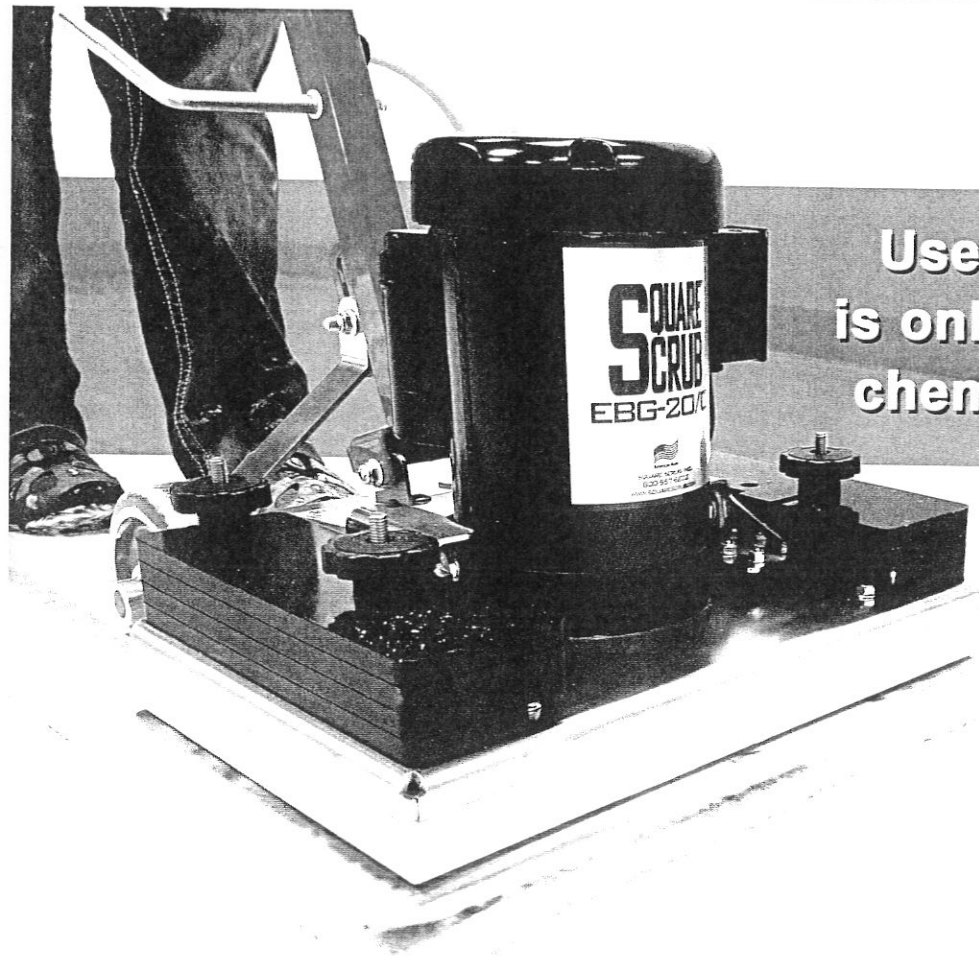

SHO PAD

10.5"	P0511SHO	20/CASE
20"	P1420SHO	5/CASE
28"	P1428SHO	5/CASE

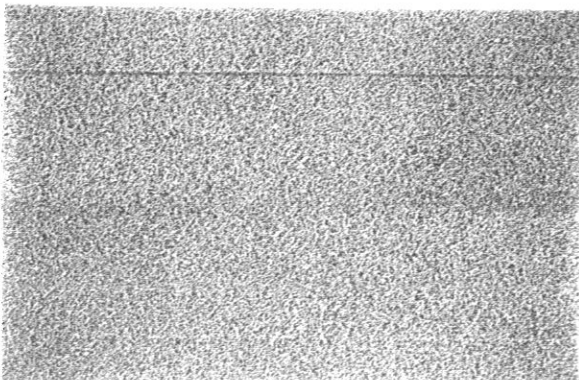

The SHO Pad is extremely abrasive and heavy, with dense fibers. Best used when dirt and buildup are severe. Use wet on VCT and tile. Use with a white or blue driver to protect the grip face. Inspect driver every 15 minutes.

***Specifications & information contained in this catalog are subject to change without notice.

Driver Pads

WHITE DRIVER

10.5"	P0511DRIVER	48/CASE
20"	P1420DRIVER	10/CASE
28"	P1428DRIVER	10/CASE

1/4" thick pad used primarily as a spacer pad. Use this pad with sandpaper and diamonds. Always check spacer pad. DO NOT USE WITH ABRADER PLATE!

Preferred Driver

BLUE DRIVER

10.5"	P0511BLU	18/CASE
20"	P1420BLU	5/CASE
28"	P1428BLU	5/CASE

Ideal for use as a spacer between the machine & other pads, because of its superior ability to hold its form. It can also be used for heavier cleaning & buffing.

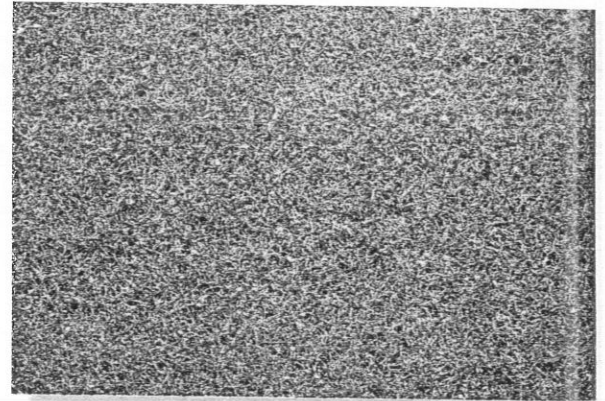

RED DRIVER

20"	P1420RED	5/CASE
28"	P1428RED	5/CASE

Primarily used as a spacer pad between the machine and other pads. It's a light cleaning pad that can also be used for both heavy cleaning & buffing.

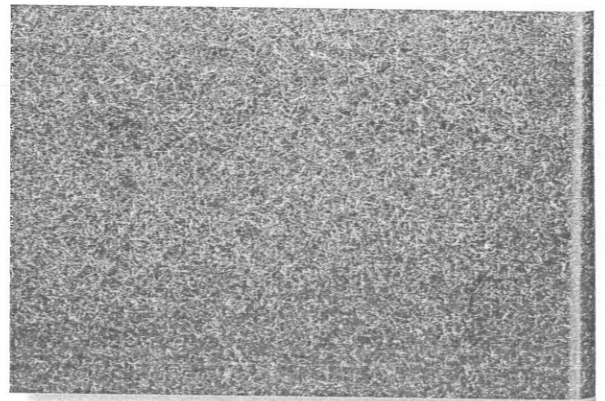

Cleaning & Buffing Pads

XTREME SPONGE

10.5"	P0511XTR	5/CASE
20"	P1420XTR	5/CASE
28"	P1420XTR	5/CASE

Use the Xtreme Sponge to remove scuff marks on VCT or bathroom tile. A little water and this melamine pad deep cleans and restores shine between refinishing jobs. Use wet on VCT and tile.

Removes Scuff Marks

WHITE PAD

10.5"	P0511WHT	16/CASE
20"	P1420WHT	5/CASE
28"	P1420WHT	5/CASE

The White Pad is used as a light duty polish pad. This 1" thick pad is used without a driver pad, and is great for spreading chemicals while buffing.

Driver Pad Care = Longer Grip Face Life

Scan Me!



Grip Face Care
Instructions

Checking driver pads regularly is key to a long lasting grip face. All driver pads wear out. The amount of time a driver pad will last varies greatly based on the task being done.

WWW.SQUARESCRUB.COM

800-557-6822

***Specifications & information contained in this catalog are subject to change without notice.

The Square Scrub® EBG-20/C has earned the Carpet and Rug Institute's Bronze Seal of Approval for Superior Deep Cleaning.

SQUARE SCRUB

Versatility²

www.squarescrub.com | 800-557-682



Microfiber Carpet Cleaning Pad

MICROFIBER CARPET CLEANING PAD—P1420CB

SOLD INDIVIDUALLY

Combined with Square Scrub® Encapsulating Carpet Cleaner, the Microfiber Carpet Cleaning Pad deep cleans even the highest traffic carpeting. Quicker drying time.

Use wet on any carpeted surface.

Durable!
Lasts up to 50
wash cycles.

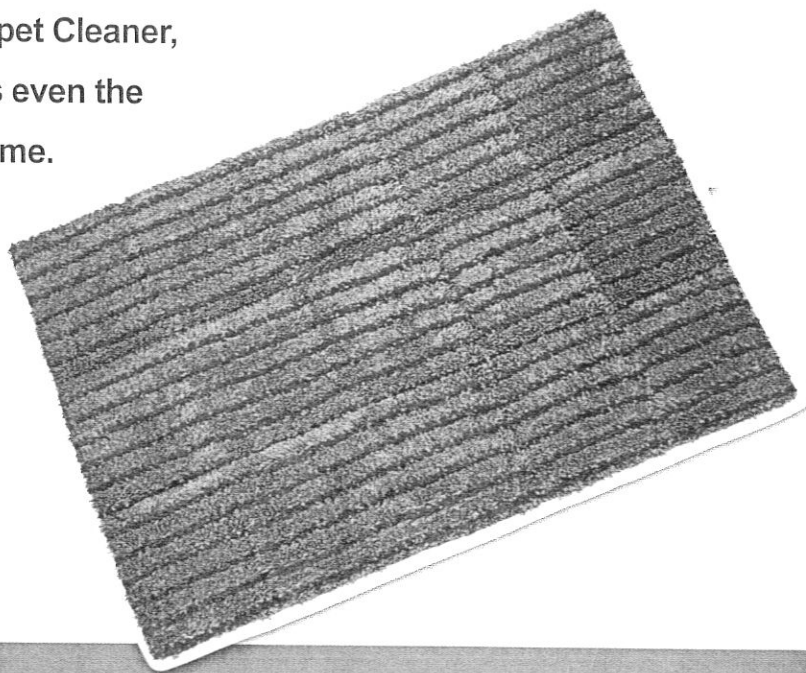

Encapsulating Carpet Cleaner

ENCAPSULATING CARPET CLEANER

1 GAL BOTTLES
SOLD INDIVIDUALLY

Designed for use with the Square Scrub® Microfiber Carpet Cleaning Pad. Square Scrub® Encapsulating Carpet Cleaner captures soil and dries to a non-sticky crystal that can be vacuumed up, and disposed of easily. Only 8 oz. required per gallon. A significant savings over other encapsulation cleaners.

This product is Carpet and Rug Certified.



***Specifications & information contained in this catalog are subject to change without notice.

Screening

SANDSCREENS

10/CASE

	14x20	14x28
60 Grit	S1420060	S1428060
80 Grit	S1420080	S1428080
100 Grit	S1420100	S1428100
120 Grit	S1420120	S1428120
150 Grit	S1420150	S1428150
180 Grit	S1420180	S1428180

Sandscreens are ideal for finish removal, or repair of wood floor surfaces. Screens can be used to repair painted floor surfaces. Both sides of screens can be used. Use with a thin White Driver Pad or Blue Driver Pad. Use wet or dry on wood or painted concrete.

Flat, Consistent, Even Screening

Productivity²[®]

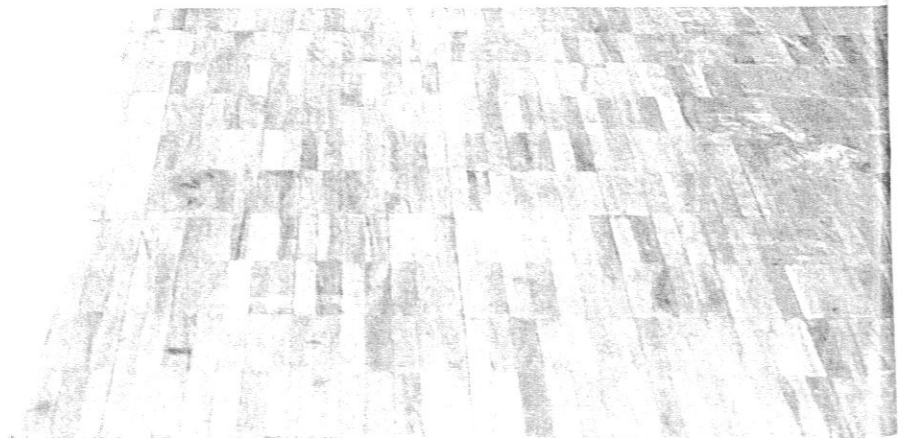

Never underestimate the power of a straight line.

At Square Scrub[®], a straight line means efficiency. The ability to control your movement allows you to do more with one pass. Using an EBG machine helps you prep the work area faster and more efficiently, so you can move on to the next job.

Gymnasium Floors

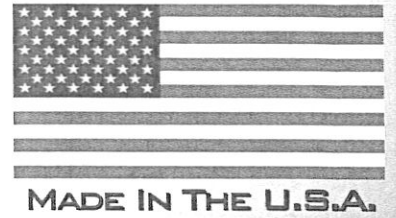

**Screen Gym Floors up
to 10,000 sq ft/hr***

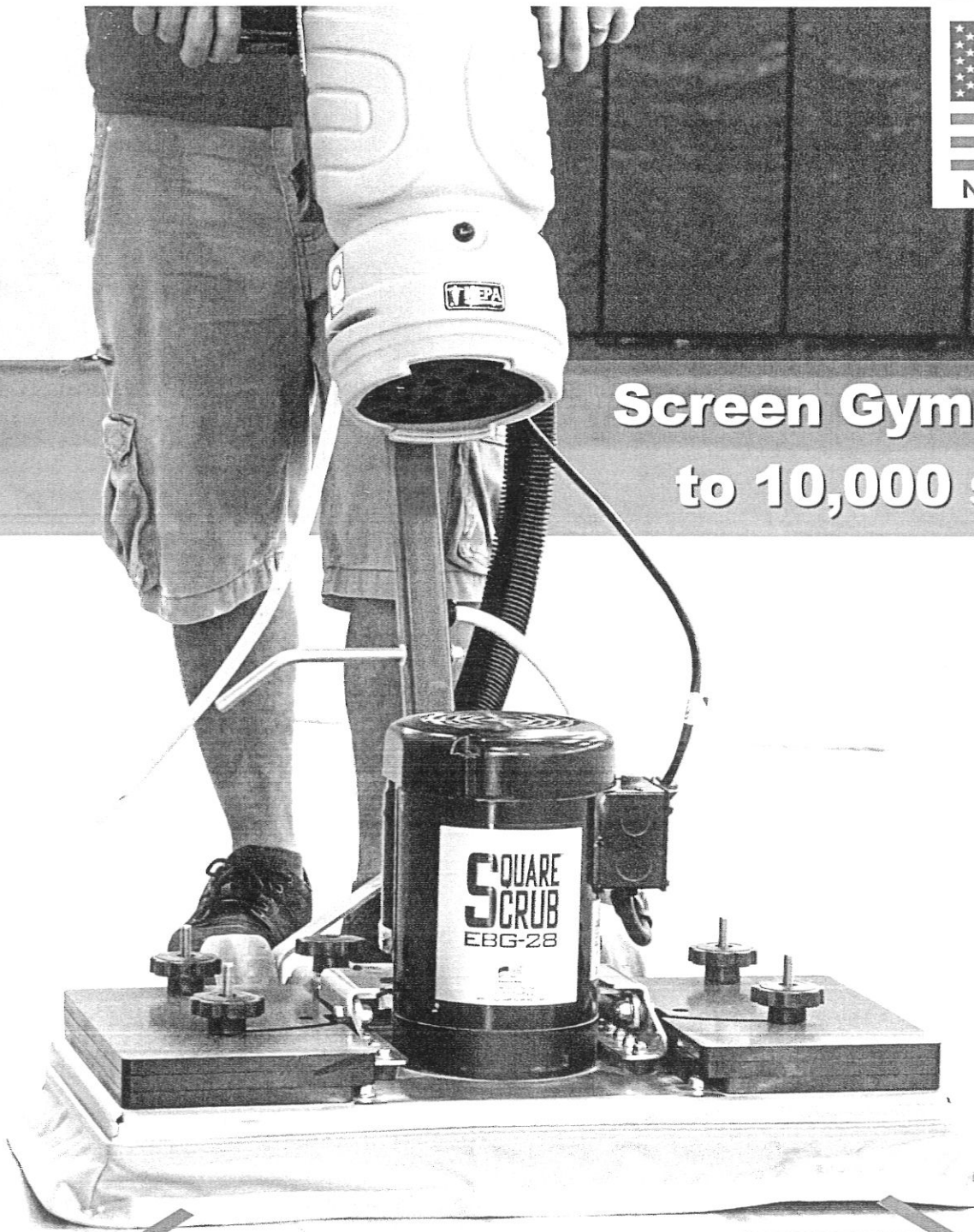

28 INCHES OF

SANDING AND

SCREENING POWER

*EBG-28 Machine results may vary.

***Specifications & information contained in this catalog are subject to change without notice.

Sanding

PRO SANDPAPER
SOLD INDIVIDUALLY

14x20

14x28

16 Grit	PPSP1319016	PPSP1327016
24 Grit	PPSP1319024	PPSP1327024
36 Grit	PPSP1319036	PPSP1327036
60 Grit	PPSP1319060	PPSP1327060
80 Grit	PPSP1319080	PPSP1327080
100 Grit	PPSP1319100	PPSP1327100

Our Pro Sandpaper is double-sided & longer lasting than standard sandpaper, cutting paper usage drastically!

With grits ranging from the ultra-aggressive 16 to the popular 100 grit, these are great for smoothing wood surfaces. Both sides of this paper can be used. Use along with the White Driver Pad. Use dry on wood flooring or decks. Our 16 grit Pro Sandpaper works great dry for gum removal on concrete!

Removes chair & drum sander marks

STANDARD SANDPAPER
20/CASE

Our Standard Sandpaper comes in a variety of grits to tackle any of your wood floor needs.

Use these for smoothing wood surfaces. Use along with the White Driver Pad.

Use dry on wood flooring or decks.

14x20

14x28

20 Grit	SP1319020	SP1327020
36 Grit	SP1319036	SP1327036
60 Grit	SP1319060	SP1327060
80 Grit	SP1319080	SP1327080
100 Grit	SP1319100	SP1327100

***Specifications & information contained in this catalog are subject to change without notice.

Hardwood Floors

**SQUARE
SCRUB**®
Versatility²

www.squarescrub.com | 800-557-6822



— Sands flat & even —

Easy to Control

***Specifications & information contained in this catalog are subject to change without notice.

Abrasion

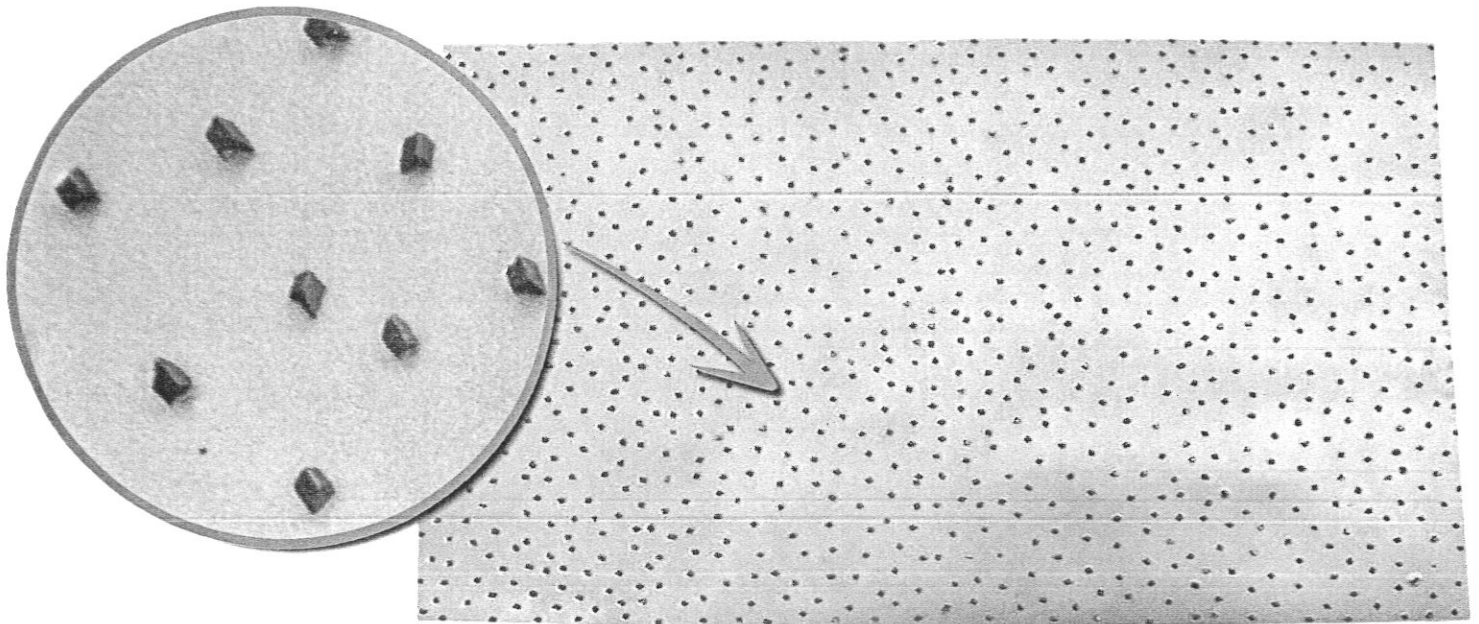

Abrader Plate - SAP

20" - P1319SAP

SOLD INDIVIDUALLY

Carbide Tungsten steel abrader tool. Designed for heavy duty use, including linoleum removal, glue, or paint on concrete. Always use wet!

**SQUARE[®]
SCRUB** Versatility²

www.squarescrub.com | 800-557-6822



**Hand scraping is going to
take a while...**

Epoxy Removal

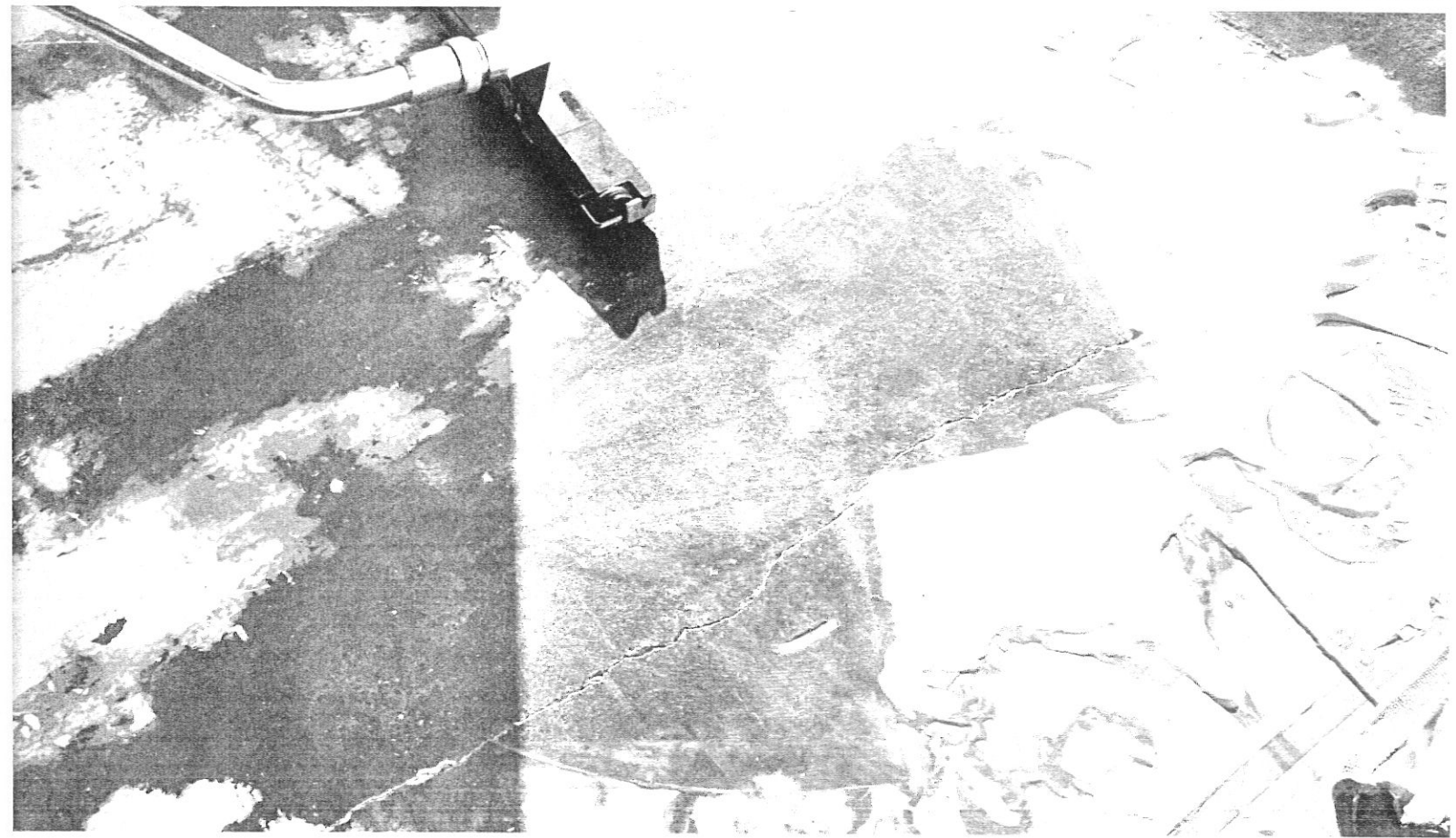

Carpet Glue Removal

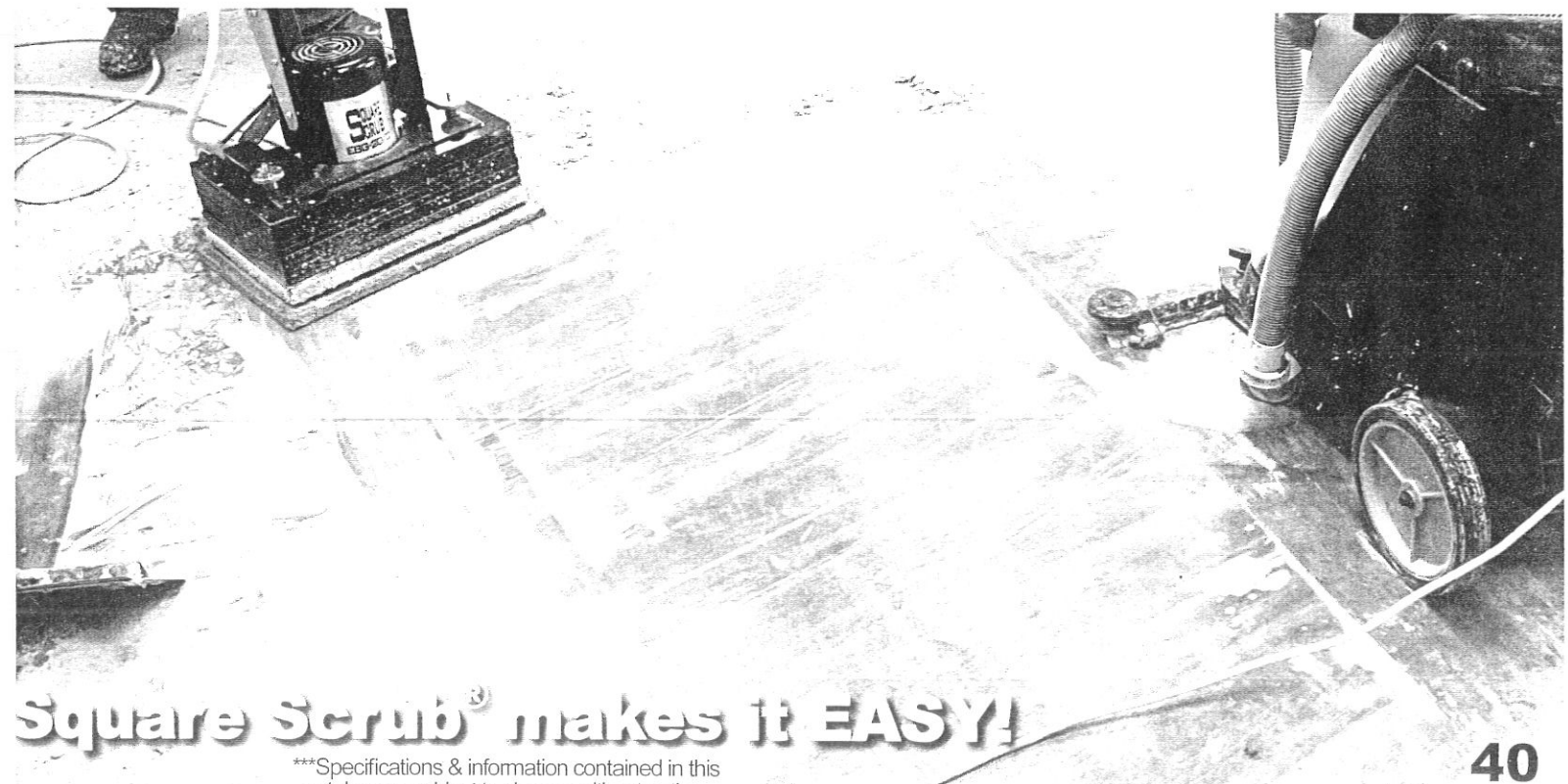

Square Scrub[®] makes it EASY!

***Specifications & information contained in this catalog are subject to change without notice.

Made in the U.S.A.

Proud to be American Made

Square Scrub® machines are built in Jonesboro, AR.

Our machines are truly American Made. The steel used in our frame comes from Arkansas. The Leeson motor is made in Black River Falls, WI. We believe in American made products, and the opportunities created by supporting American companies. That is why we make every effort to incorporate components that are made right here in the United States of America.

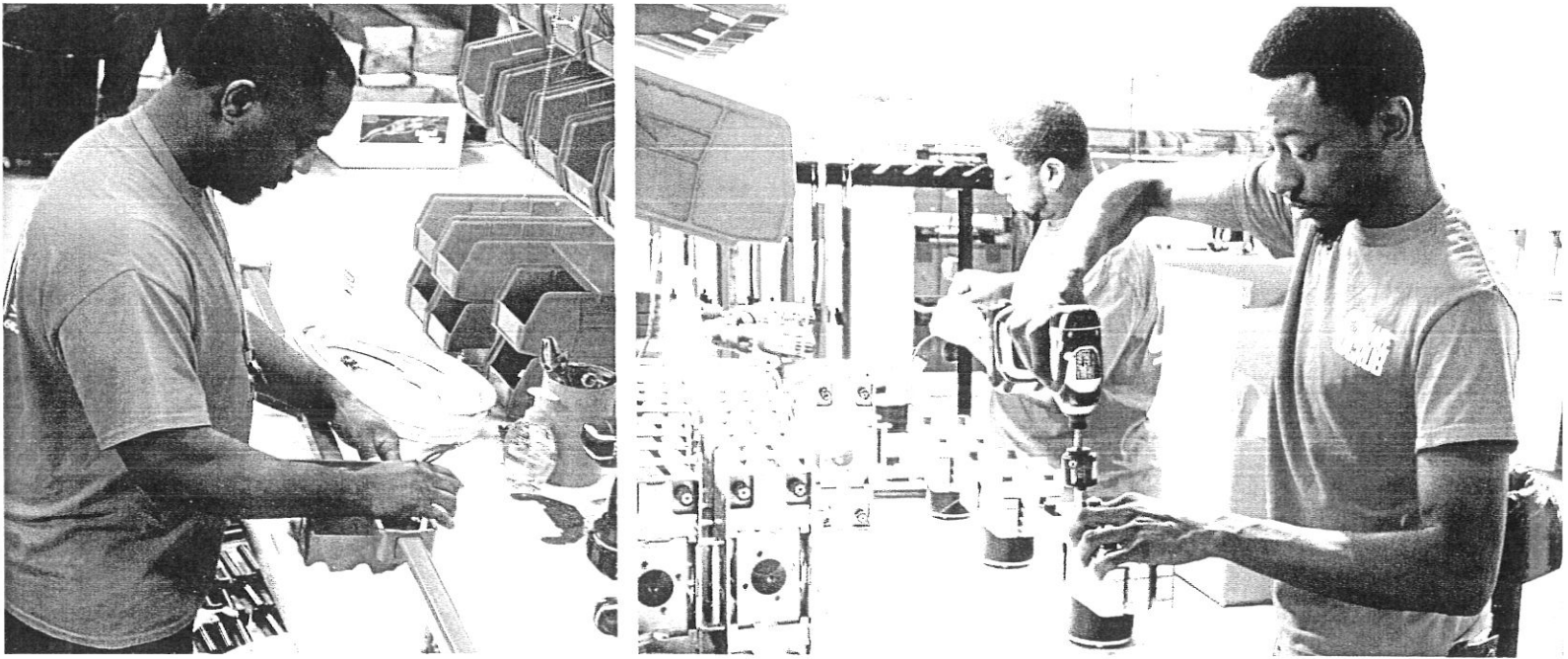

Quality Control

Every machine we build is quality tested and inspected. We care about the reputation of American made products, so we strive to build a sturdy, hard-working, solid machine that is **BUILT TO LAST!**



Craftsmanship

Fast Delivery

Time is Money

At Square Scrub[®], we know that your time is valuable. Our machines are designed to save you time, affording more money making opportunities. We know that you don't have time to wait weeks for your machine. That is why we strive to fulfill every machine order within one day of receiving an order. For pads and accessories, we do our best to get them out to you the next day, so you can get to work ASAP!

**SQUARE
SCRUB** [®]
Versatility²



Connect With Us



800-557-6822
WWW.SQUARESCRUB.COM

***Specifications & information contained in this catalog are subject to change without notice.

Compact & Powerful

**Doodle
SCRUB**
BY SQUARE SCRUB

UL/CSA/CE Certified	Yes
Total Assembled Weight	23 lbs
Maximum Weight Capacity	N/A
Powder Coated Steel Frame	10 gauge
3/4 " Solid Steel Axle	N/A
Handle Attachment Points	2
6"x2" Non-Marking Wheels	N/A
Motor	4100 rpm
Operating Sound Output	50 db
Power Cord	30ft/18 gauge
Lighted Plug	N/A
Amp Draw	1.2 amps
Pad Size	5.25x10.5
Number of Isolators	4
Oscillations	4100/min
Removable Weights	N/A
Slotted Weights	N/A
Vibration Reducing Isolated Handle	N/A
Noise Reducing Weight Spacers	N/A
Stone Care Capable	Yes
Carpet & Rug Institute Certified	N/A
Dust Containment Kit	N/A
Built-in Hour Meter	N/A
Two-Piece Handle	N/A

EBC₉
BY SQUARE SCRUB



*Machine shown with optional carry strap.

Versatility²

EBC_{20/C} BY SQUARE SCRUB



UL/CSA/CE Certified	Yes
Base Weight w/o Weights	106 lbs
Total Assembled Weight	156 lbs
Maximum Weight Capacity	232 lbs
Powder Coated Steel Frame	10 gauge
Stainless Steel Base	7 gauge
3/4 " Solid Steel Axle	Yes
Adjustable Handle	Yes
6"x2" Non-Marking Wheels	Yes
Motor	3450 1.5 hp
Operating Sound Output	69 db
Power Cord	50 ft/14 gauge
Lighted Plug	Yes
Amp Draw	7 amps
Pad Size	14x20
Number of Isolators	4
Oscillations	3450/minute
Removable Weights	Yes
Slotted Weights	Yes
Vibration Reducing Handle	Yes
Noise Reducing Weight Spacers	Yes
Stone Care Capable	Yes
Carpet & Rug Institute Certified	Yes
Dust Containment Kit	Included
Built-in Hour Meter	Optional
Two-Piece Handle	Optional



*Machine shown with optional HEPA Vac Kit.

The EBC-20/C is the only orbital floor machine that is CRI Certified.

***Specifications & information contained in this catalog are subject to change without notice.

Productivity²

EBC₂₈

BY SQUARE SCRUB



Intertek
4004125
ETL/CSA/CE

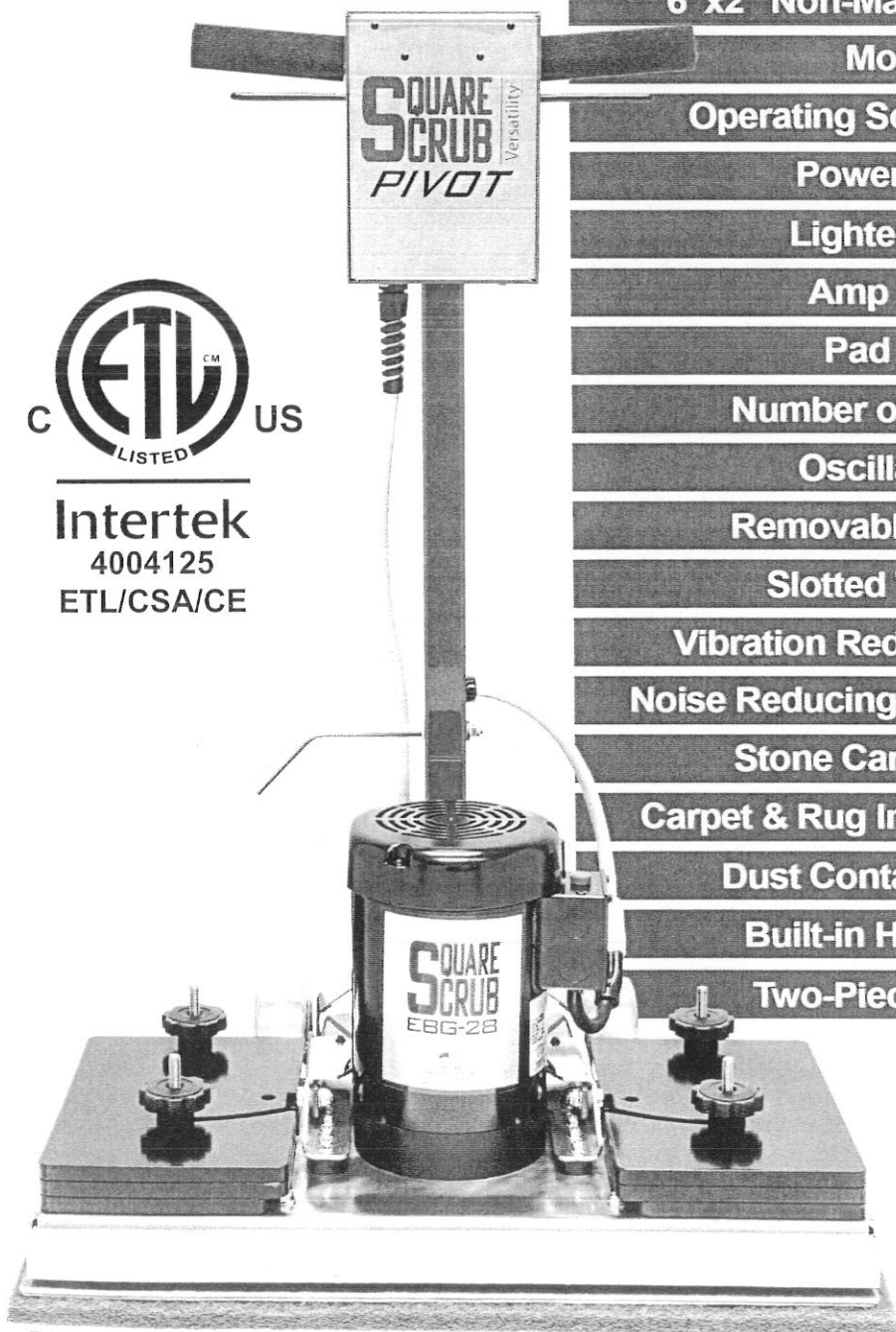

UL/CSA/CE Certified	Yes
Base Weight w/o Weights	117 lbs
Total Assembled Weight	197 lbs
Maximum Weight Capacity	197 lbs
Powder Coated Steel Frame	10 gauge
Stainless Steel Base	7 gauge
3/4 " Solid Steel Axle	Yes
Adjustable Handle	Yes
6"x2" Non-Marking Wheels	Yes
Motor	3450 1.5 hp
Operating Sound Output	69 db
Power Cord	50 ft/14 gauge
Lighted Plug	Yes
Amp Draw	9.6 amps
Pad Size	14x28
Number of Isolators	8
Oscillations	3450/minute
Removable Weights	Yes
Slotted Weights	Yes
Vibration Reducing Handle	Yes
Noise Reducing Weight Spacers	Yes
Stone Care Capable	Yes
Carpet & Rug Institute Certified	N/A
Dust Containment Kit	Included
Built-in Hour Meter	Optional
Two-Piece Handle	Optional

SQUARE SCRUB[®]

Versatility²

***Specifications & information contained in this catalog are subject to change without notice.

Economical

EBC_{20/E}
BY SQUARE SCRUB

TO BE
ANNOUNCED

SQUARE[®]
SCRUB Versatility²
PIVOT

EBC SERIES
BY SQUARE SCRUB

FLOOR PREPARATION MACHINES

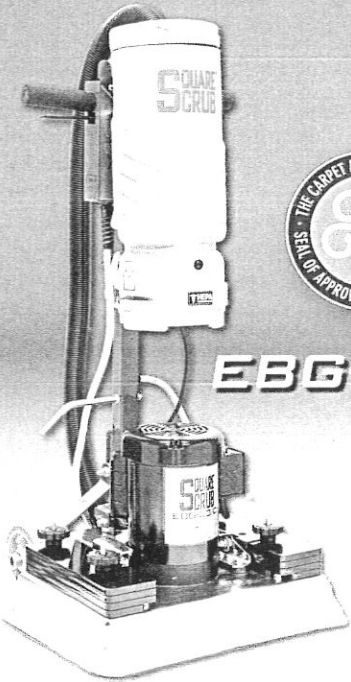

EBC-20/C

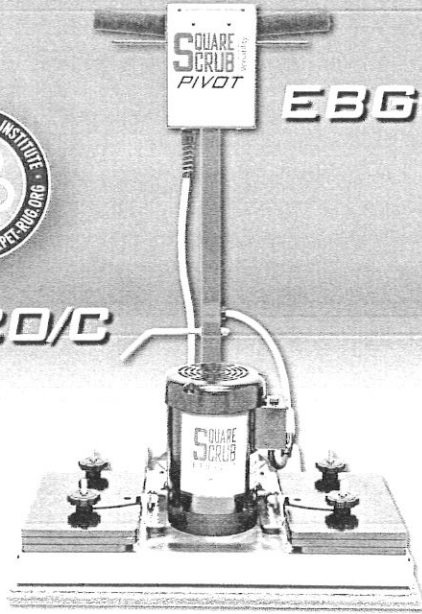

EBC-28

EBC-9-SKATE

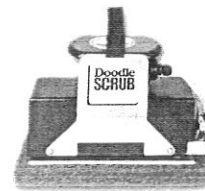
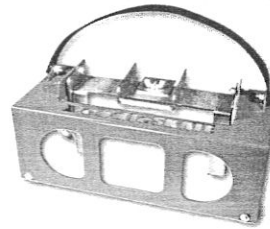

EBC-9

WE MAKE FLOOR PREP WORK EASY

Connect with us



Square Scrub®
P.O. Box 1693
Jonesboro, AR 72403
800.557.6822
www.squarescrub.com

SQUARE SCRUB®
Versatility²

www.squarescrub.com | 800-557-6822